

Installation & Operation Manual

Full Inverter Swimming Pool Heat Pump



Contents

1. Safety Consideration
2. Delivery
3. Specification
4. Dimension
5. Installation
6. Electric wiring
7. Operation
8. WiFi connection
9. Parameter & Error codes
10. Exploded view
11. Operation logic
12. Maintenance
13. Winter Use

1.Regulation (EU) n° 517/2014 of 16/04/14 on fluorinated greenhouse gases and repealing Regulation (EC) n° 842/2006

Leak checks

1. Operators of equipment that contains fluorinated greenhouses gases in quantities of 5 tons of CO₂, equivalent or more and not contained in foams shall ensure that the equipment is checked for leaks.

2. For equipment that contains fluorinated greenhouse gases in quantities of 5 tons of CO₂ equivalent or more, but of less than 50 tons of CO₂ equivalent: at least every 12 months.

Picture of the equivalence CO₂

1. Load in kg and Tons amounting CO₂.

Load and Tons amounting CO₂

Frequency of test

From 7 at 75 kg load = from 5 at 50 Tons

Each year

Concerning the Gas R32, 7.40kg amounting at 5 tons of CO₂, commitment to check each year.

Training and certification

1. The operator of the relevant application shall ensure that the relevant personnel have obtained the necessary certification, which implies appropriate knowledge of the applicable regulations and standards as well as the necessary competence in emission prevention and recovery of fluorinated greenhouse gases and handling safety the relevant type and size of equipment.

Record keeping

1. Operators of equipment which is required to be checked for leaks, shall establish and maintain records for each piece of such equipment

specifying the following information:

- a) The quantity and type of fluorinated greenhouse gases installed;
- b) The quantities of fluorinated greenhouse gases added during installation, maintenance or servicing or due to leakage;
- c) Whether the quantities of installed fluoridate greenhouse gases have been recycled or reclaimed, including the name and address of the recycling or reclamation facility and, where applicable, the certificate number;
- d) The quantity of fluoridate greenhouse gases recovered
- e) The identity of the undertaking which installed, serviced, maintained and where applicable repaired or decommissioned the equipment, including, where applicable, the number of its certificate;
- e) The dates and results of the checks carried out;
- f) If the equipment was decommissioned, the measures taken to recover and dispose of the fluoridate greenhouse gases.

2. The operator shall keep the records for at least five years, undertakings carrying out the activities for operators shall keep copies of the records for at least five years

1. SAFETY CONSIDERATION

Please read this manual carefully before proceeding with the installation or operation our pool heat pumps. This manual contains all necessary information for installation and operation and error codes. Installers must read the manual and follow the implementation and maintenance instructions carefully.

The installation should be done by the professional technicians, to prevent leaking, electric shock or fire. The ground wire must be connected for safety.

WARNING: Please drain water out from the heat pump unit if heat pump stopped to use in cold weather, otherwise it would be damaged by water freezing inside titanium exchanger, if ambient temperature dropped to below 0°C, which should be out of warranty by any improper use.

WARNING: It must be cut off the power supply before opening or repairing the heat pump by qualified technician, otherwise ,it is high risk to cause any body injured.

WARNING: Keep the display controller in a dry place, or close the insulating cover to protect the display controller from moisture damage.

CAUTION :

- a. When installing the heat pump in a small room, make sure it is well ventilated.
- b. Do not put fingers or objects into the air inlet, because the rotating fan may cause serious injury.
- c. If you smell anything burning, turn off the manual power switch immediately, stop operation and contact the after-sale service department. Continued abnormal operation may cause electric shock fire.
- d. When the unit needs to be removed or re-installed, it must be carried out by qualified technicians. If the installation is not correct, it may cause unit operation failure, electric shock, fire, hurt, leaking, etc.
- e. Do no install the unit near flammable sources, as any leakages could cause a fire.
- f. Make sure the base on which the unit is installed is strong enough to support it.
- g. It is necessary to install a proper circuit breaker to prevent electric shock or fire.
- h. When cleaning the unit, it must be stopped operation, switch off and disconnect the power .



2. DELIVERY

2.1 Delivery of the unit



For the transportation, the heat pumps are fixed on the pallet and covered with a cardboard box. To protect from any damage, the heat pump must be transferred in its package. It is the responsibility of the addressee to notify of any damage incurred during delivery within 48 hours. No responsibility can be taken once the unit has been signed for.

2.2 Stock advice



- * The warehouse should be bright, spacious, open, well ventilated, have ventilation equipment and no fire source.
- * Heat pumps must be stored and transferred in vertical position in its original packaging. If it is not the case, it cannot be operated until a minimum period of 24H has passed before the unit can have the electrical power turned on.

FORBIDDEN



2.3 Transfer to the final position

- * During the unpacking of the product and the transfer from the pallet to the final place of installation, it is necessary to maintain the heat pump in a vertical position.
- * Smoking and the use of flames are prohibited near R32machine.
- * Water connection are not to be used as load bearing handles. The manufacturer would not take the responsibility in case of damage to the water pipes.

3. SPECIFICATION

Model No.	CHP-SPARK-7	CHP-SPARK-10	CHP-SPARK-13	CHP-SPARK-17	CHP-SPARK-21
* Heating Capacity at Air 26°C, Humidity 80%, Water 26°C in, 28°C out					
Heating Capacity (kW)	7.6~1.7	9.5~2.3	13~3.0	17~3.8	21~4.8
Power Input (kW)	1.12~0.11	1.40~0.15	1.91~0.19	2.5~0.24	3.09~0.30
COP	15.8~6.8	15.8~6.8	16~6.8	15.8~6.8	15.8~6.8
* Heating Capacity at Air 15°C, Humidity 70%, Water 26°C in, 28°C out					
Heating Capacity (kW)	6.1~1.4	7.6~1.9	9.8~2.3	13.5~3	16.5~3.8
Power Input (kW)	1.24~0.18	1.55~0.25	1.96~0.30	2.76~0.39	3.37~0.5
COP	7.6~4.9	7.6~4.9	7.6~5	7.6~4.9	7.6~4.9
* Cooling Capacity at Air 35°C, Water 29°C in, 27°C out					
Cooling Capacity (kW)	4.2~1.0	5.3~1.3	7.2~1.7	9.4~2.1	11.6~2.7
Power Input (kW)	1.11~0.15	1.4~0.19	1.89~0.25	2.47~0.31	3.05~0.4
EER	6.6~3.8	6.7~3.8	6.7~3.8	6.7~3.8	6.7~3.8
Power supply	220~240V~/50Hz				
Max Power Input (kW)	1.55	1.78	2.2	2.6	3.2
Max Current (A)	7.3	8.3	10.2	12	14.7
Water Flow Volume (m ³ /h)	2.5	3.5	4.5	5.5	6.5
Refrigerant	R32				
Heat Exchanger	Titanium heat exchanger in PVC				
Air Flow Direction	Horizontal				
Kind of defrost	Hot-gas defrosting				
Working temp. range	-15~43(Heating mode)				
	8~43(Cooling mode)				
	-15~43(Auto mode)				
Setting temp. range	8~40(Heating mode)				
	8~28(Cooling mode)				
	8~40(Auto mode)				
Water Proof Level	IPX4				
Noise level 1m dB(A)	39~49	40~52	42~53	43~55	45~56
Noise level 10m dB(A)	20~29	20~32	22~33	23~35	25~36
Net Weight	42kg	43kg	53kg	54kg	58kg
Gross Weight	53kg	54kg	64kg	65kg	69kg
Net Dimensions	864*349*592mm		925*364*642mm		
Package Dimensions	930*400*640mm		990*435*760mm		

Model No.	CHP-SPARK-30	CHP-SPARK-35
* Heating Capacity at Air 26°C, Humidity 80%, Water 26°C in, 28°C out		
Heating Capacity (kW)	28~6.8	35~8.8
Power Input (kW)	4.12~0.43	5.15~0.56
COP	15.8~6.8	15.8~6.8
* Heating Capacity at Air 15°C, Humidity 70%, Water 26°C in, 28°C out		
Heating Capacity (kW)	23~5.5	25.5~6.4
Power Input (kW)	4.7~0.72	5.2~0.84
COP	7.6~4.9	7.6~4.9
* Cooling Capacity at Air 35°C, Water 29°C in, 27°C out		
Cooling Capacity (kW)	14.9~3.8	19.3~4.9
Power Input (kW)	3.92~0.57	5.08~0.73
EER	6.7~3.8	6.7~3.8
Power supply	220~240V/1/50	
Max Power Input (kW)	4.45	4.76
Max Current (A)	20.4	30
Water Flow Volume (m ³ /h)	9	12
Refrigerant	R32	
Heat Exchanger	Titanium exchanger in PVC	
Air Flow Direction	Horizontal	
Kind of defrost	Hot-gas defrosting	
Working temp. range (°C)	-15~43(Heating mode)	
	8~43(Cooling mode)	
	-15~43(Auto mode)	
Setting temp. range	8~40(Heating mode)	
	8~28(Cooling mode)	
	8~40(Auto mode)	
Water Proof Level	IPX4	
Noise level 1m dB(A)	47~58	49~59
Noise level 10m dB(A)	27~38	29~39
Net Weight	88kg	98kg
Gross Weight	99kg	110kg
Net Dimensions	1084*399*737mm	
Package Dimensions	1146*460*862mm	

4. DIMENSION

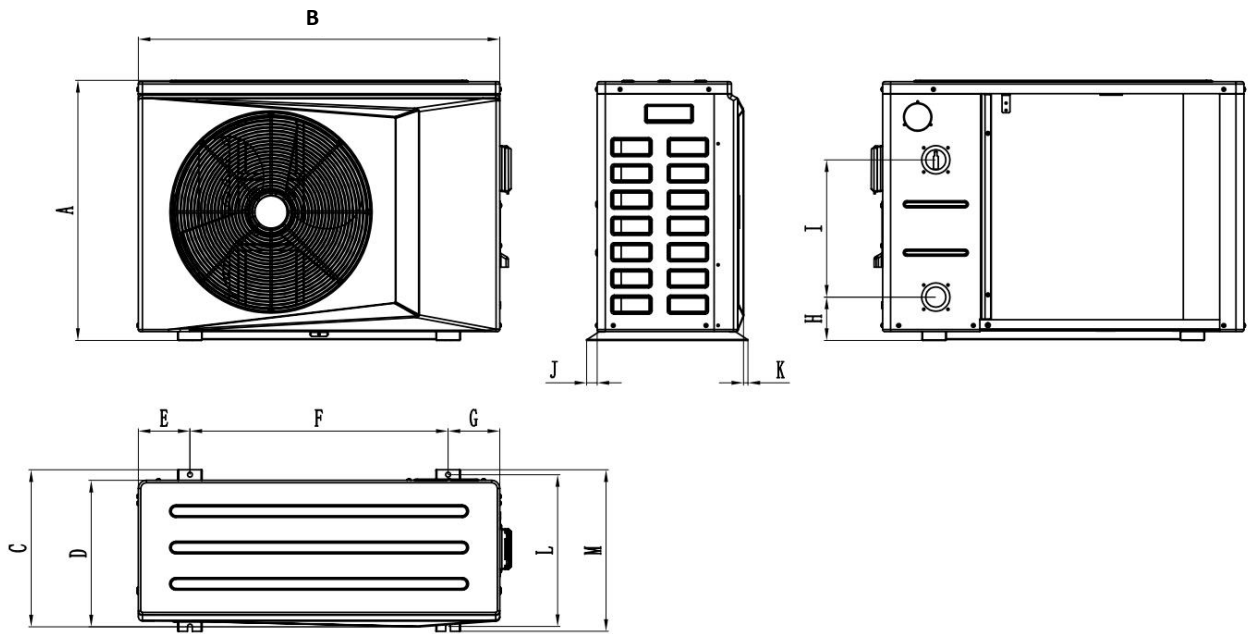

Model	A	B	C	D	E	F	G	H	I	J	K	L	M
CHP-SPARK-7 CHP-SPARK-10	591	836	379	335	98	640	98	107	290	26	11	355	379
CHP-SPARK-13 CHP-SPARK-17 CHP-SPARK-21	641	896	389	363	128	640	128	107	340	26	11	376	400
CHP-SPARK-30 CHP-SPARK-35	740.5	1056	428	401	173	710	173	101.5	440	27	17	421	445

5. INSTALLATION

5.1 Heat pump location

The unit will work properly in any desired location as long as the following three items are present:

1. Fresh air
2. Electricity
3. Swimming pool filters

The unit may be installed in virtually any outdoor location as long as the specified minimum distances to other objects are maintained. Please consult your installer for installation with an indoor pool. Installation in a windy location does not present any problem at all.

ATTENTION: Never install the unit in a closed room with a limited air volume in which the air expelled from the unit will be reused, or close to shrubbery that could block the air inlet. Such locations impair the continuous supply of fresh air, resulting in reduced efficiency and possibly preventing sufficient heat output.

Note: If automatic dosing equipment for chlorine and acidity (pH) is used, it is essential to protect the heat pump against excessively high chemical concentrations which may corrode the heat exchanger. For this reason, equipment of this sort must always be fitted in the piping on the downstream side of the heat pump, and it is recommended to install a check-valve to prevent reverse flow in the absence of water circulation. Damage to the heat pump caused by failure to observe this instruction is not covered by the warranty.

Please observe the space requirements indicated below for optimal operation and maintenance.

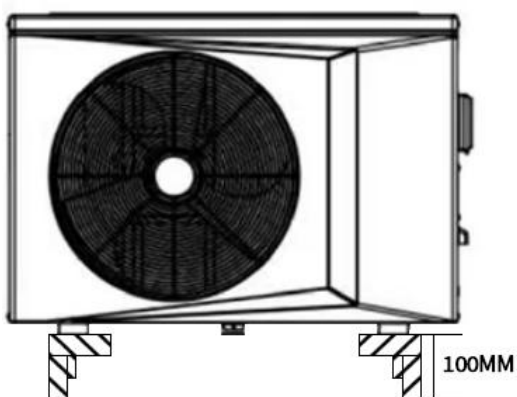
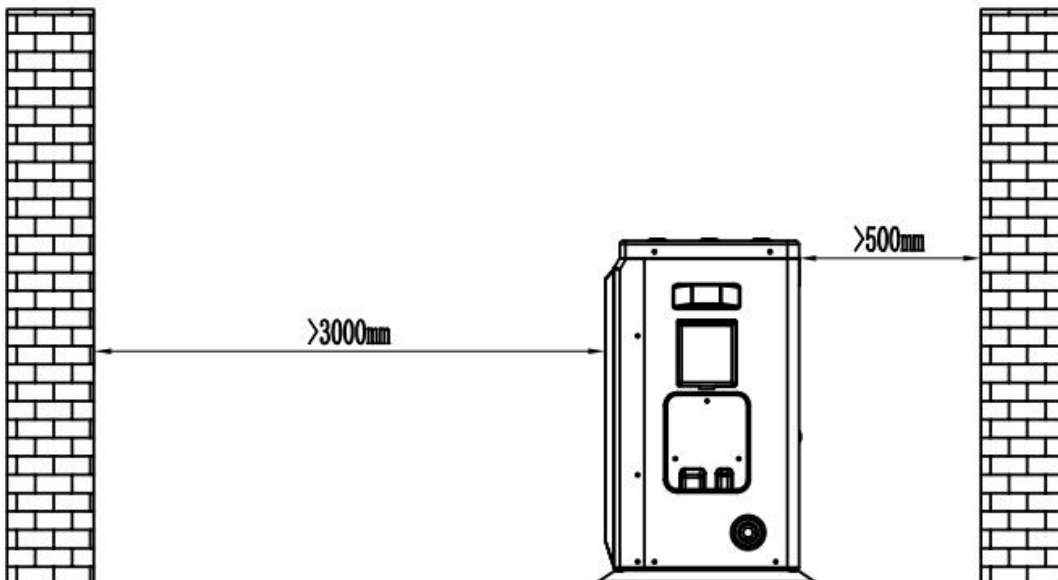
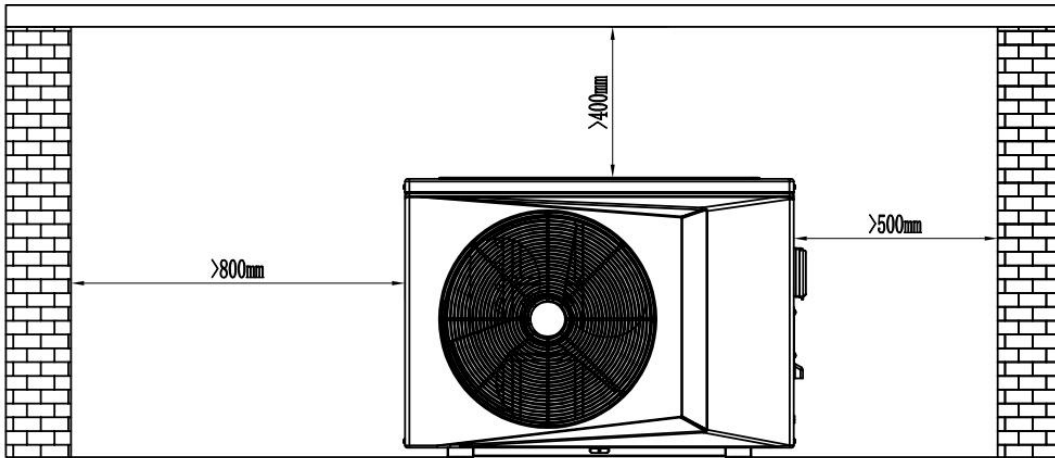

5.3 Pipeline installation diagram

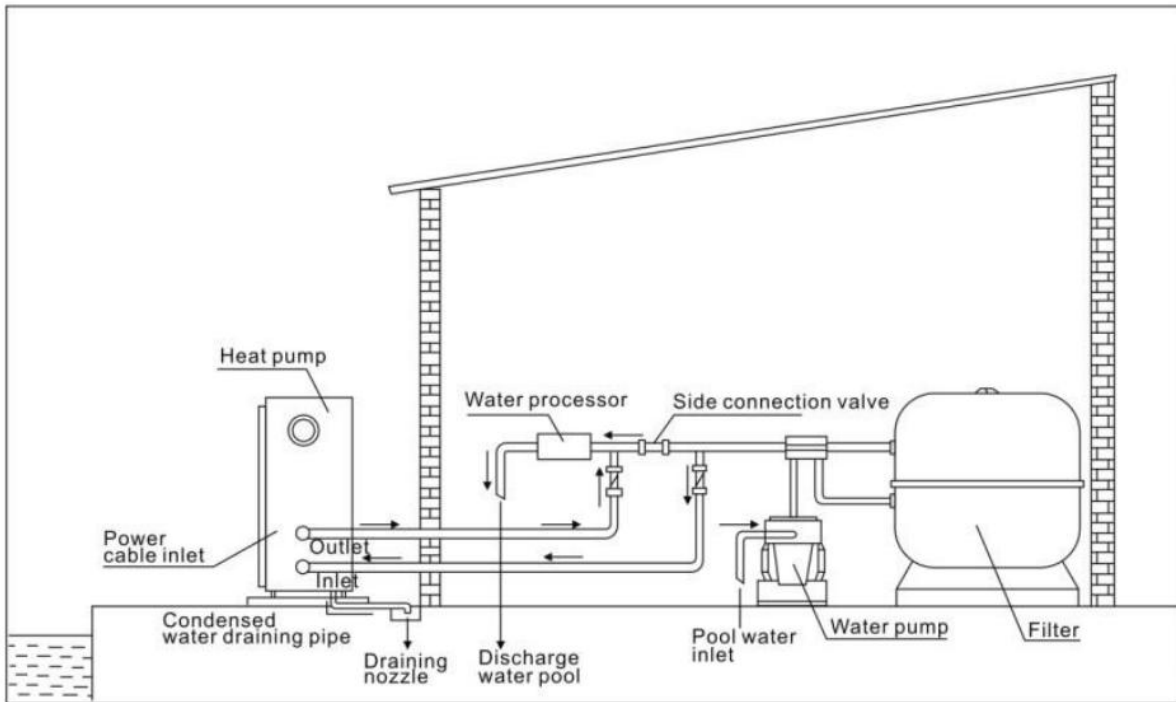

ATTENTION:

Please observe the following rules when installing the heat pump:

1. Any addition of chemicals must take place in the piping located downstream from the heat pump.
2. Always keep the heat pump upright. If the unit has been held at an angle, wait at least 24 hours before applying mains power to the heat pump.
3. In order to heat the water in the pool or (hot tub), the filtration water pump should be running, while it stops, heat pump should be stopped accordingly.

5.4 Installation check

ATTENTION:

- A. Avoid installations in locations containing mineral oil.
 - B. Avoid installation in locations where the air contains salt or other corrosive gases.
 - C. Avoid installation in locations with serious power supply voltage fluctuation.
 - D. Avoid installation in unstable places, such as a car or cabin.
 - E. Avoid installation near flammable items.
 - F. Avoid installation in locations with strong electromagnetic forces.
 - G. Avoid installation in locations with harsh environmental conditions.
- a. Check the model, number, name etc, to avoid incorrect installation.
 - b. Make sure there is enough space for installation and maintenance.
 - c. Install in a dry well-ventilated place and make sure there are no obstructions around the air inlet and outlet.
 - d. Make sure the supporting base is strong enough and prepared to that shocks can be avoided.

- e. The power supply and diameter of the cables used must be in accordance with the electrical installation requirements.
- f. Electrical installation must comply with the relevant technical standards of electrical equipment, and electrical insulation work must be done.
- g. The unit must be put horizontally for at least eight hours before running.

5.5 The By-Pass Kit

The By-Pass Kit is the essential accessory for the installation of your heat pump, it is also a tool for the optimization of the heating of the water. The valves allows the optimum flow of water using a manometer to make sure the optimized running of the compressor, see paragraph 5.6 controls of the pressure.



5.6 Installation of pipe

- ① Prevent air, dust and other material from going into the water pipes.
- ② Fix the whole system before installing the water pipes.
- ③ Water inlet and outlet pipes should be protected by an insulation layer.
- ④ Make sure that there is a stable water flow, to prevent excessive throttling.
- ⑤ Do not handle, move or lift the unit by holding the water inlet and outlet pipe: use only the holes on the beam of the base.
- ⑥ When connecting the water inlet and outlet pipes, use two pipe wrenches to adjust the two parts of the pipes, and make sure the water inlet and outlet pipes do not twist.

6. Electrical Wiring

6.1 Electric connection

The power supply for the heat pump must come, preferably, from an exclusive circuit with regulatory protection components (30mA differential protection) and a magneto-thermal switch.

- The electrical installation must be carried out by a specialized professional (electrician) in accordance with the standards and regulations in force in the country of installation.

- The heat pump circuit must be connected to a safety earth circuit at the terminal block. - The cables must be

properly installed to prevent interference.

- The pump is intended for connection to a general power supply with earth connection. - Section of the cable; This section is indicative and should be checked and adapted according to the needs and conditions of use.

- The tolerance of acceptable voltage variation is +/- 10% during operation. The connections must be measured according to the power of the device and the state of installation

The unit should have a dedicated power supply in accordance with the recommended voltage.

6.2 Electrical Wiring Specification

The connections must be dimensioned according to the power of device and the state of installation.

Models	Circuit breaker	Electrical Wiring Specification	Maximum length of the wire			
			2.5mm ²	4mm ²	6mm ²	10mm ²
CHP-SPARK-7	16A	3*1.5 mm ²	84m	135m	200m	335m
CHP-SPARK-10	16A	3*1.5 mm ²	57m	90m	130m	225m
CHP-SPARK-13	16A	3*2.5 mm ²	57m	90m	130m	225m
CHP-SPARK-17	16A	3*2.5 mm ²	34m	54m	80m	135m
CHP-SPARK-21	20A	3*4 mm ²	29m	45m	66m	110m
CHP-SPARK-30	40A	3*4 mm ²	/	25m	38m	62m
CHP-SPARK-35	40A	3*6mm ²	/	/	22m	36m

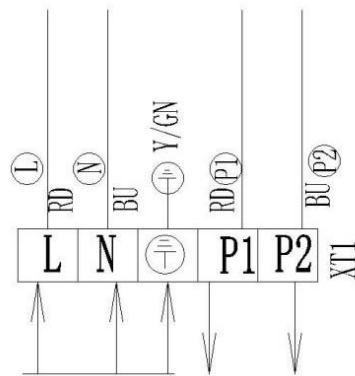

Power In To Pump, Maximum : 250W

AC:220V~240V / 50 Hz AC: 220V~240V/ 50 Hz

6.3 Circulation pump connection

The heat pump only provides a signal for the circulation pump, A separate A.C. Contactor is required to connect circulation pump.

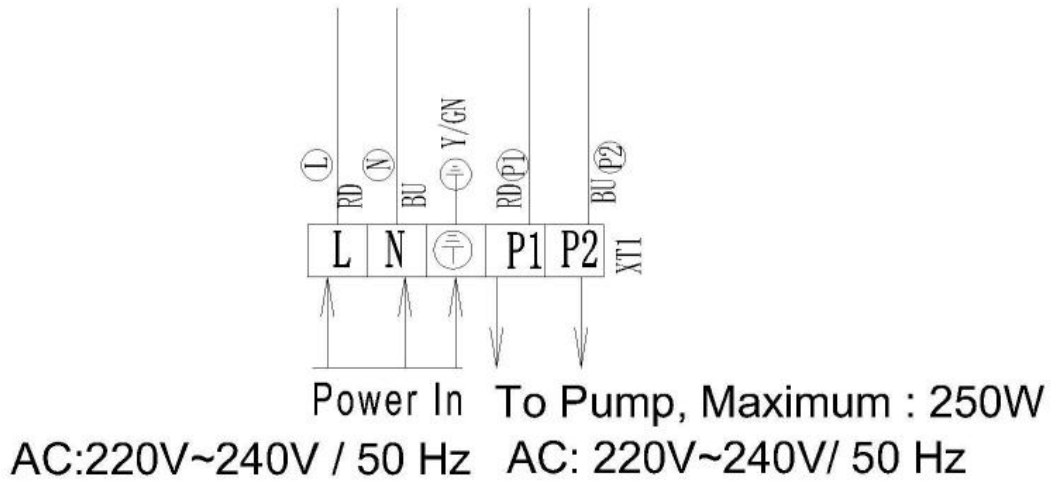

NOTE:

If the pump power less than 250w, please connect the pump as this drawing.

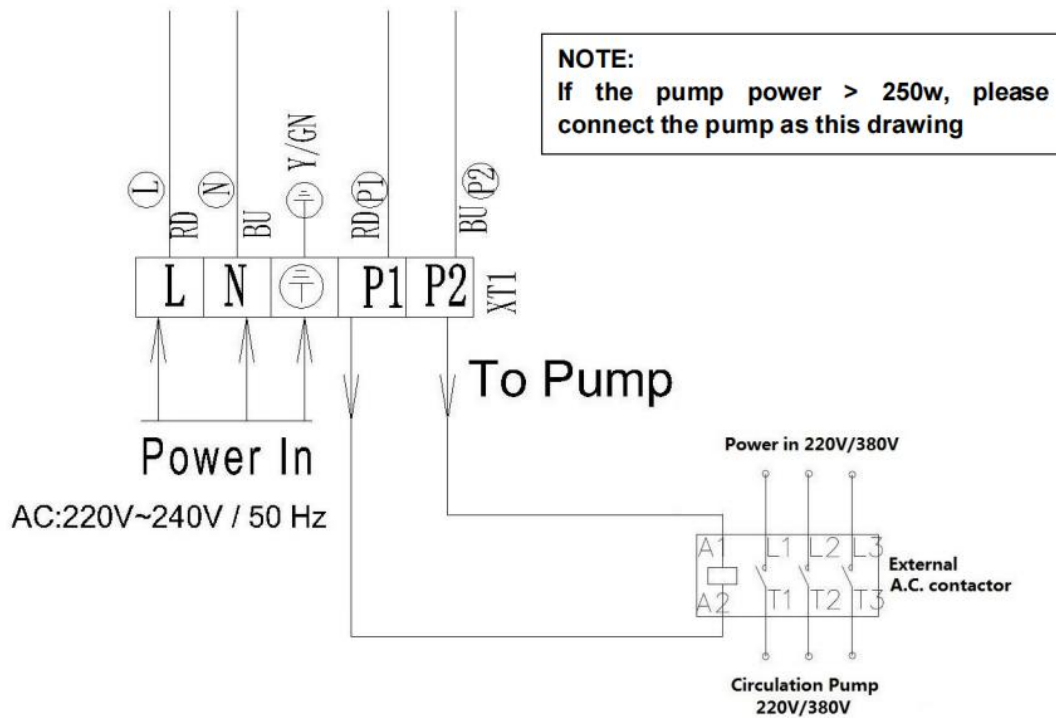

6.4 Electric wiring diagram

COMP : Compressor	GND : Ground
AMBT: Ambient temperature sensor	WFS: Water flow switch
LOW : Low pressure switch	HIGH : High pressure switch
COIL: Evaporator Coil Temperature Sensor	OWT/INWT: Inlet/ Outlet water temperature sensor

CHP-SPARK-7

32190001000345

WIRE COLOR CODE	Full name
BK	BLACK
PL	PURPLE
BU	BLUE
RD	RED
WH	WHITE
GN	GREEN
YL	YELLOW
Outlet Temp.	Outlet water temperature sensor
Inlet Temp.	Inlet water temperature sensor
Suc. Temp.	Suction temperature sensor
Exhaust Temp.	Exhaust temperature sensor
Amb. Temp.	Ambient temperature sensor
Coil Temp. 2	Coil temperature sensor 2
Coil Temp. 1	Coil temperature sensor 1
MF	Constant Current Motor Fan
4WV	4 way valve
HPS	High pressure switch
LPS	Low pressure switch
WFS	Water flow switch
COMP	Compressor
LED	LED Lamp
XT1	Terminal
EEV1	Electronic Expansion Valve

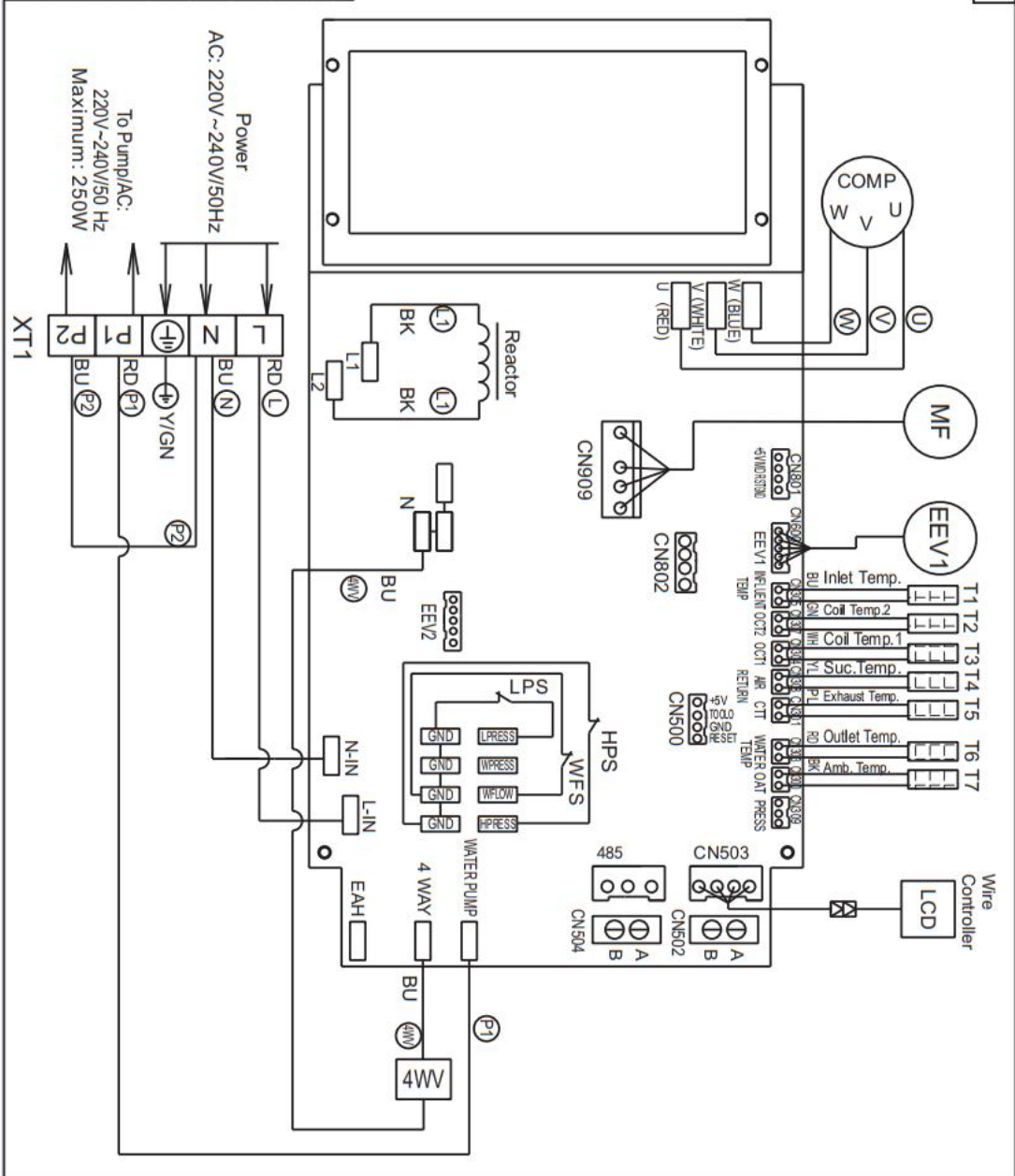

CHP-SPARK-10

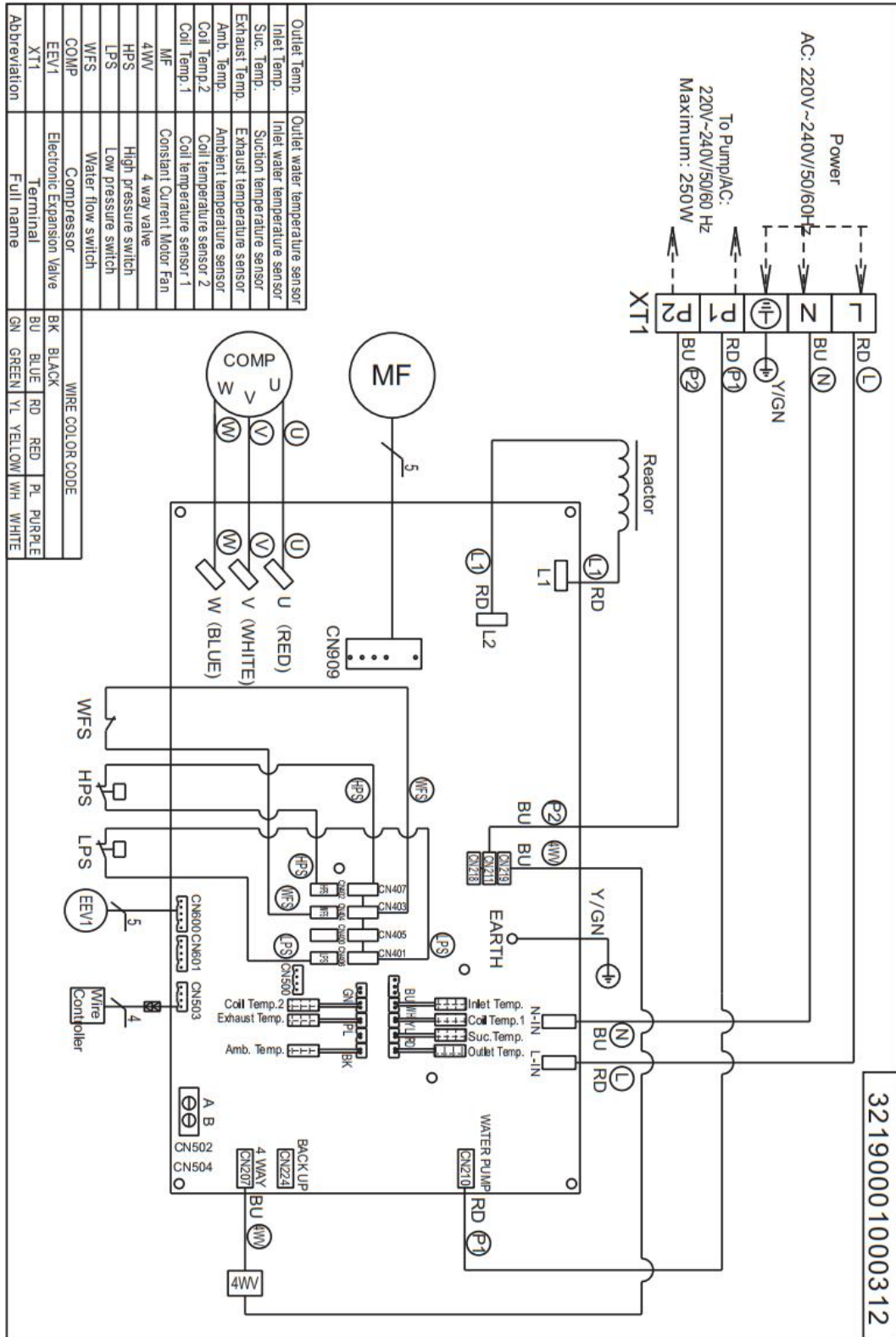

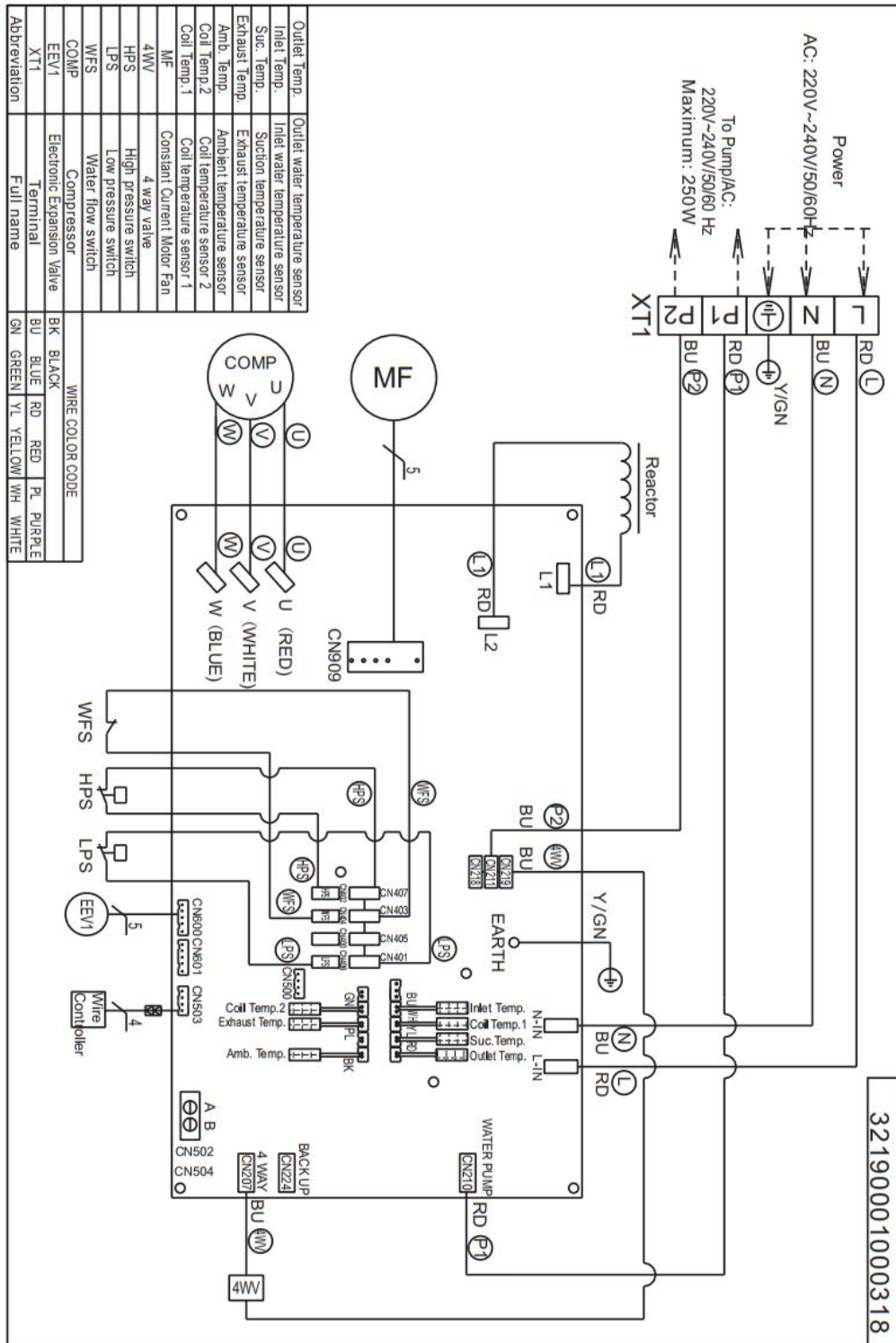

CHP-SPARK-17

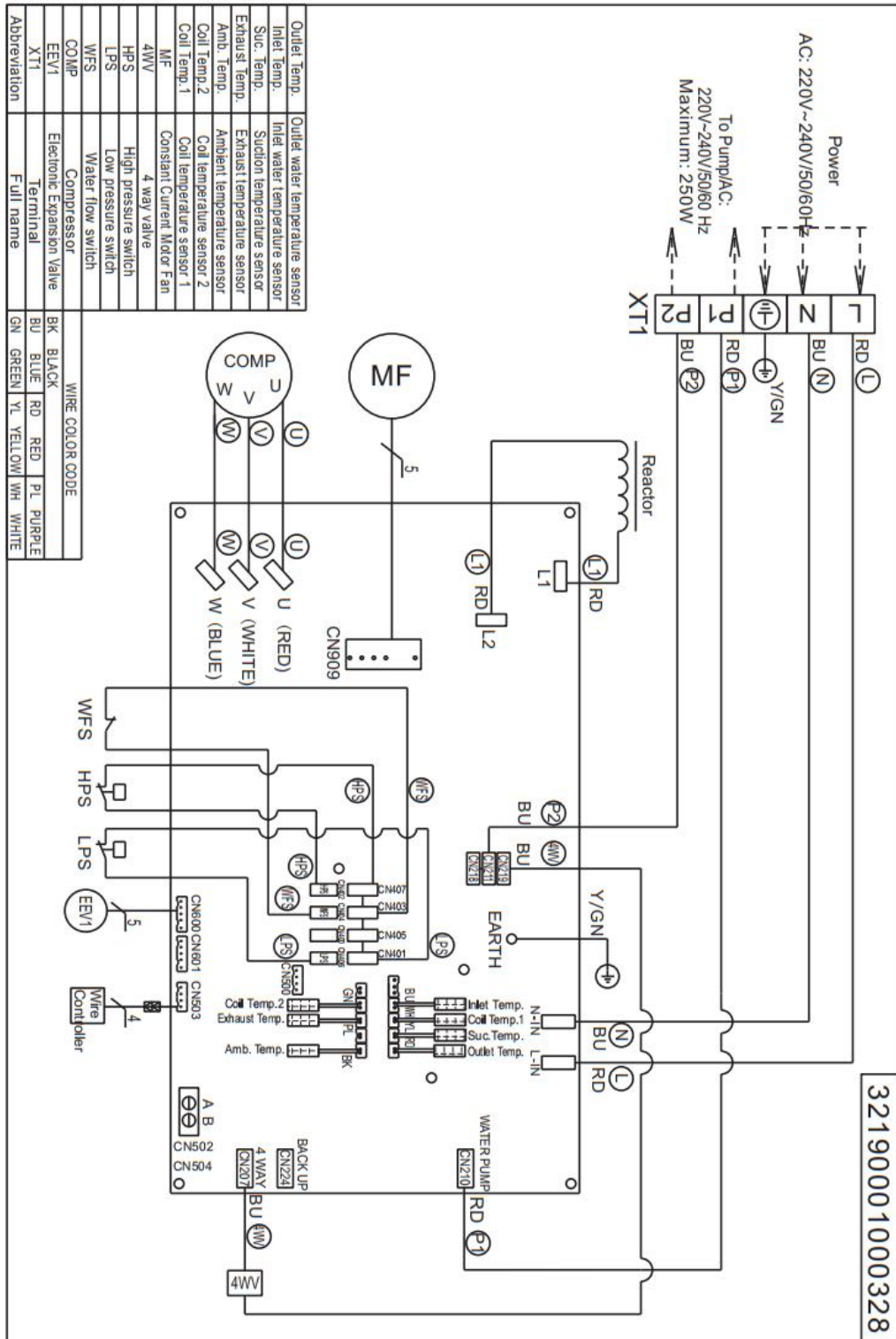

CHP-SPARK-21

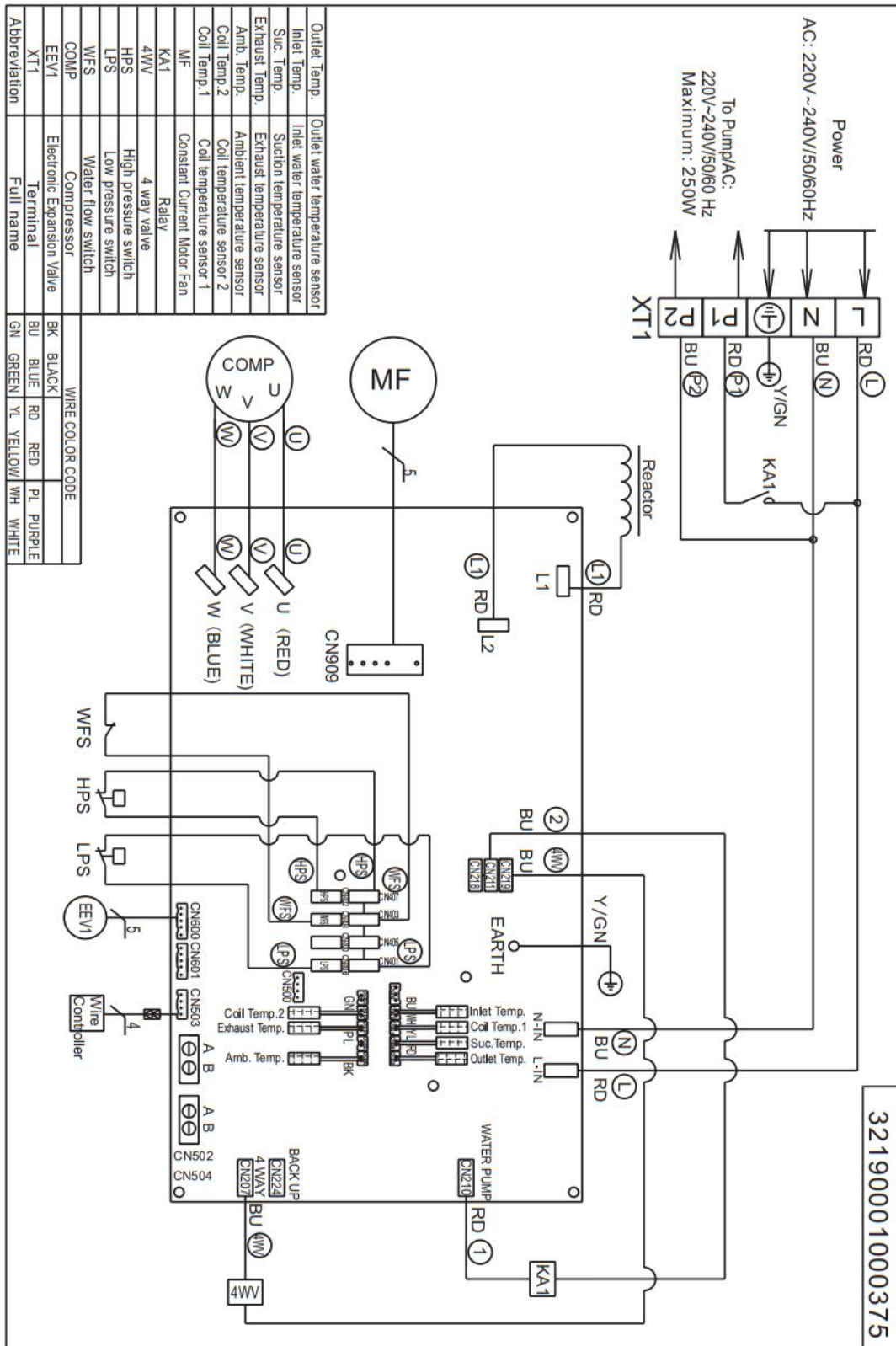

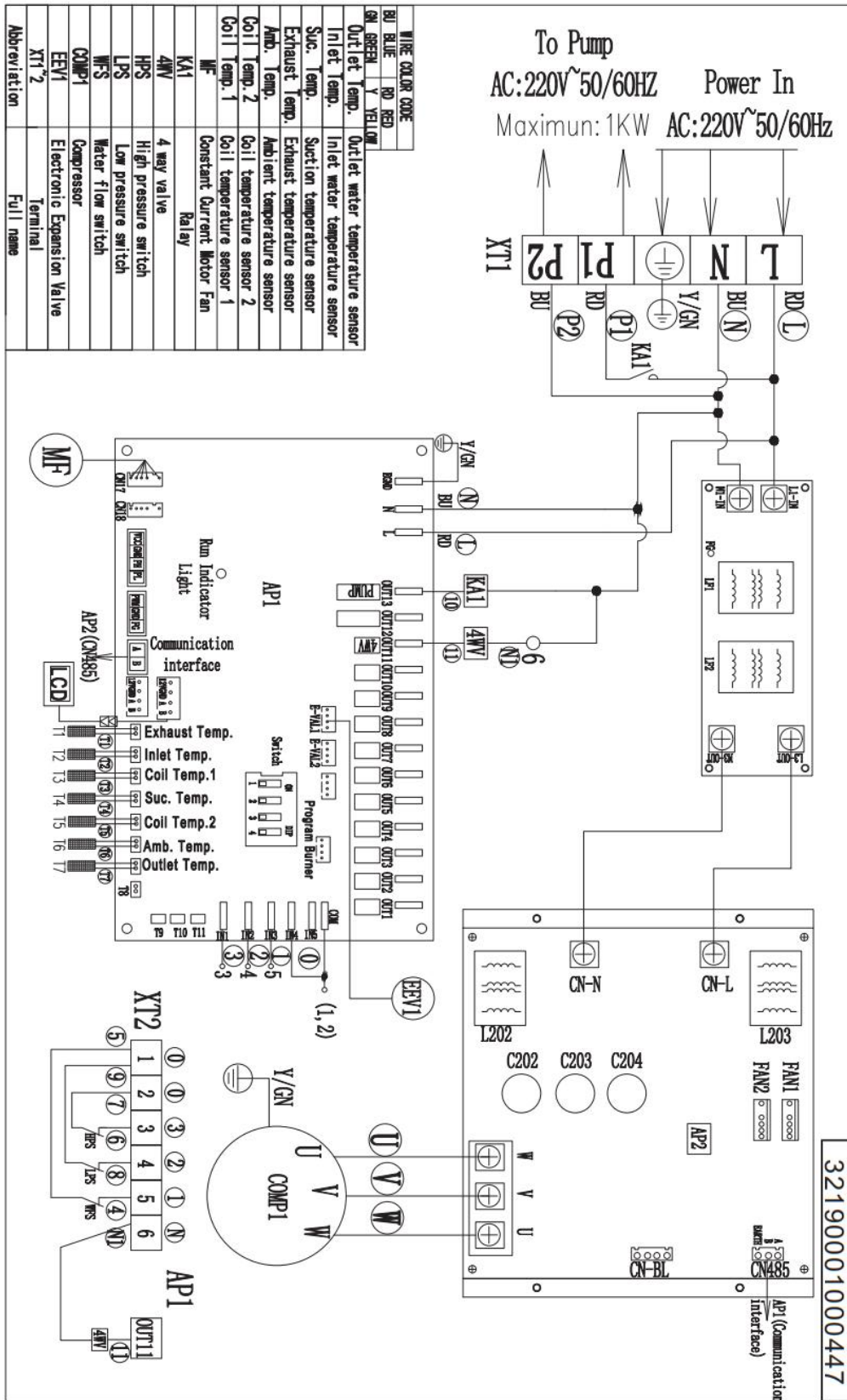

7. OPERATION

7.1 Initial operation

After all connections have been made and checked, carry out the following procedure:

1. **Switch on the filtration pump.** Check for leaks and verify that water is flowing to and from the swimming pool.
2. **Connect power** to the heat pump and press the On/Off button on the electronic control panel. The unit will start up after the time delay expires (see below).
3. After a few minutes, **check whether the air blowing out of the unit is cooler.**
4. When the filtration pump is turned off, the unit should also turn off automatically.
5. Allow the heat pump and the filtration pump to **run 24 hours a day until the desired water temperature is reached.**

Depending on the initial temperature of the water in the swimming pool and the air temperature, it may take several days to heat the water to the desired temperature.

Water Flow Switch: It is equipped with a flow switch for protecting the HP unit running with adequate water flow rate. It will turn on when the filtration pump runs and shut it off when the pump shuts off.

Time delay - The heat pump has a built-in 3-minute start-up delay to protect the circuitry and avoid excessive electrical contactor wear. The unit will restart automatically after this time delay expires. Even a brief power interruption will trigger this time delay and prevent the unit from restarting immediately. Additional power interruptions during this delay period do not affect the 3-minute duration of the delay.

Condensation - The air drawn into the heat pump is cooled by the operation of the heat pump for heating the pool water, which may cause condensation on the fins of the evaporator.

Note: The amount of condensation may be as much as several liters per hour at high humidity. The condensate will drain from the bottom of the heat pump. This is sometimes mistakenly regarded as a water leak.

7.2 ON/OFF and Lock Function

Icon definition





lock--The LCD is locked If the icon is lighted

7.2.1 ON/OFF Operation steps



Step1:

Press  this button one time to start/close the heat pump;

Step2: Press the  button to close the heat pump if in main menu, in other menus, press  the button back to the main menu.

7.2.2 Lock/Unlock Operation steps



7.2.3 Step1 (Lock):  The controller will be locked when holding

 for 3 seconds or the controller is standby for 60 seconds.

Any operation will be without response when it is locked. (The controller is locked if the icon

 is lighted).

Step 2 (Unlock) : Press and hold  for 3s to change the status from lock to unlock. After this Unlock operation, the controller can respond to any other demands.

7.3 Mode Selection



7.3.1 Icon definition



Energy Conservation Mode

—Select Energy Conservation Mode to work with a highly economic effect in the heat pump.



Heating Mode

—Select Heating Mode to continue heating the water to the setting temperature



Powerful Working Mode

—Select Powerful Working Mode to run with highest capacity, to reach the setting water temperature in the shortest time.



Energy Conservation Heating Mode

Powerful Heating Mode



Cooling Mode

—Select Cooling Mode to cool the water to the setting temperature.



Defrosting Mode

—The heat pump will work with a higher economic effect if Defrosting Mode is operation by system automatically or manual.



Water-Heating Mode

—This mode only use for the heating/cooling and hot water function machine.



Automatic Mode



Heat Pump Compressor run



Electric Heater run



Water Pump run



4-Way valve run



Water Inlet Temperature



Heat Pump FAN run

7.4 Operation steps

Step 1: Check icon  status (The controller is locked If the icon  is lighted).

Step 2: Press and hold  for 3s to change the status from lock to unlock.

Step 3: Press  3 seconds to select modes, the order for different modes pops up:



Energy Conservation Heating Mode



Powerful Heating Mode





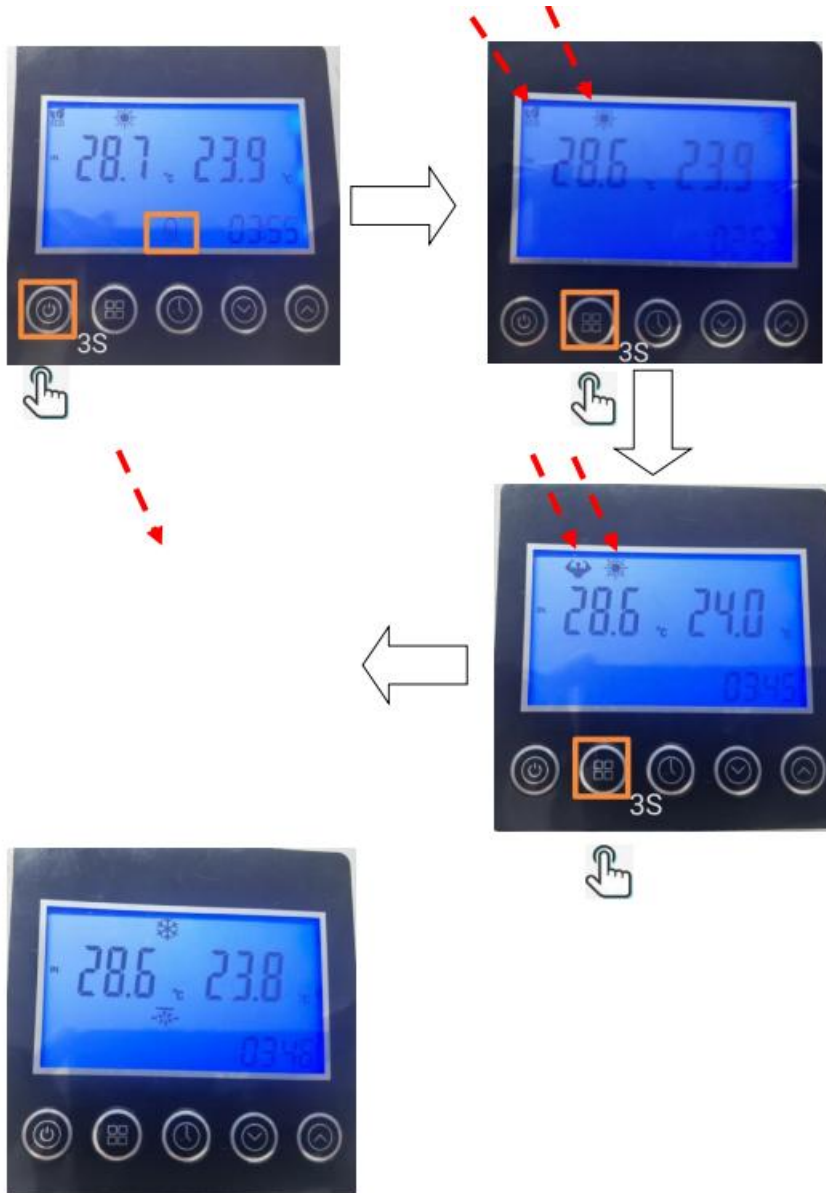



Cooling Mode (remark: mode menus are different from products, refer to chapter6)



7.5 Key Parts Working Display





-  Heat Pump compressor run
-  Electric Heater run
-  Water pump run
-  4-way valve run
-  Water inlet Temperature
-  Heat Pump Fan run



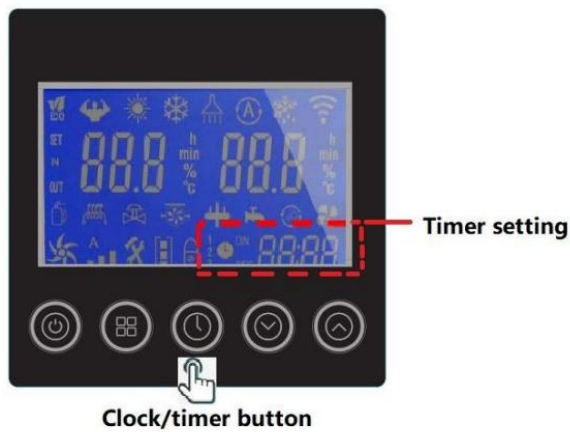



7.6 Timer setting







7.6.1 Icon Definitions

-  : Multiple phase timer setting
-  : Timer ON/OFF
-  : Time

7.6.2 Time setting operation steps

Step 1: Enter “hour” setting function after press  in main menu, “hour” flashed , press  or  to set the “hour”.

Step 2: The setting will be saved after press  when “hour” setting finished.

Step 3: Enter “minute” setting function in main menu after “hour” setting finished. “Minute” flashed , press  or  to set the “Minute”.

Step 4: The setting will be saved after press  when “Minute” setting finished.

EXAMPLE: If you would like to set 08:15, please follow below operations:

(remark:  mean first operating)

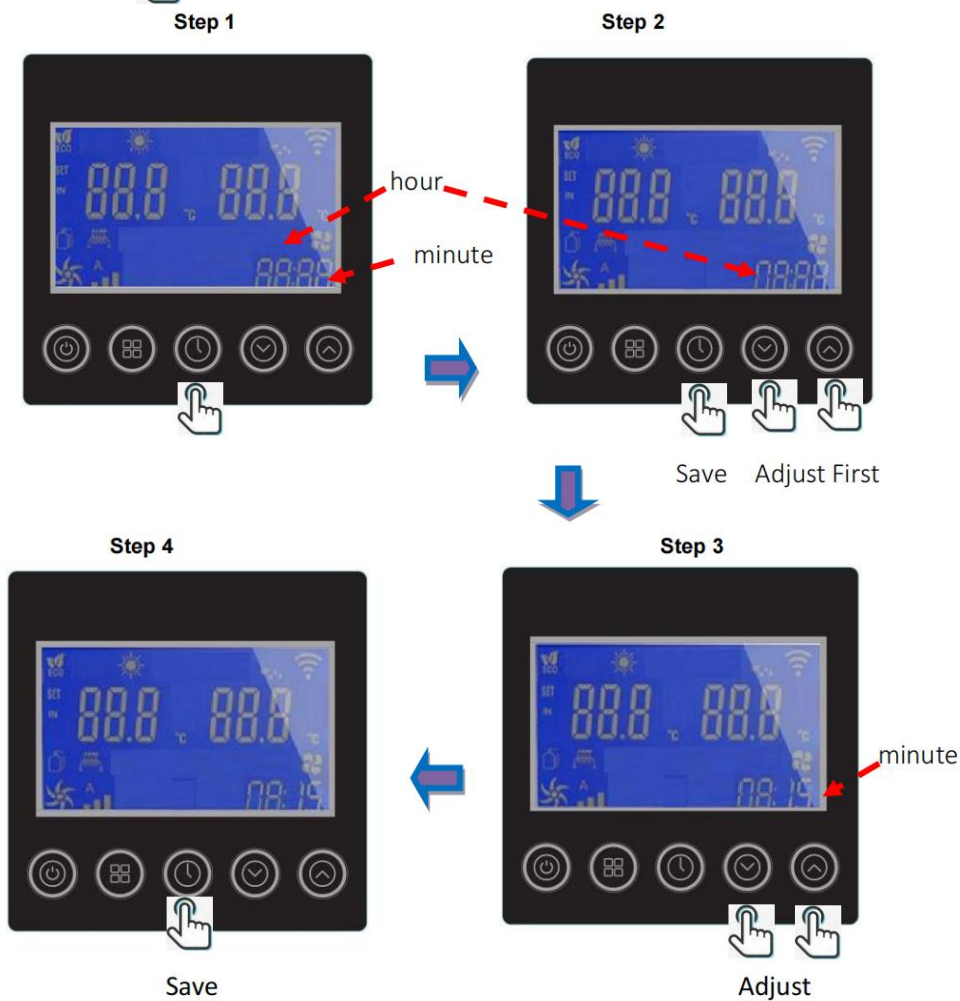









7.7 Timer Operation Steps

The Phase 1 timer on/off setting:

Step 1: Press and hold  for 3S until  icon will be lighted, enter the 1st

phase timer setting function. The "hour" will be flashed .

Step 2: Press  or  to set "hour" when "hour" flashed . The setting will be saved after press .

Step 3: The "Minute" will flash  after "hour" setting. Press  or  to set the "Minute". The 1st phase ON timer setting will be saved after press , then it goes into next step - 1st phase OFF timer setting.

Step 4:  icon will be lighted after Step 3 finished, the 1st phase OFF timer setting

same as above Step 1 & 2. After hour and minute setting, please press  to save 1st phase ON/OFF timer and return to main menu when "Minute" flashing.

EXAMPLE:

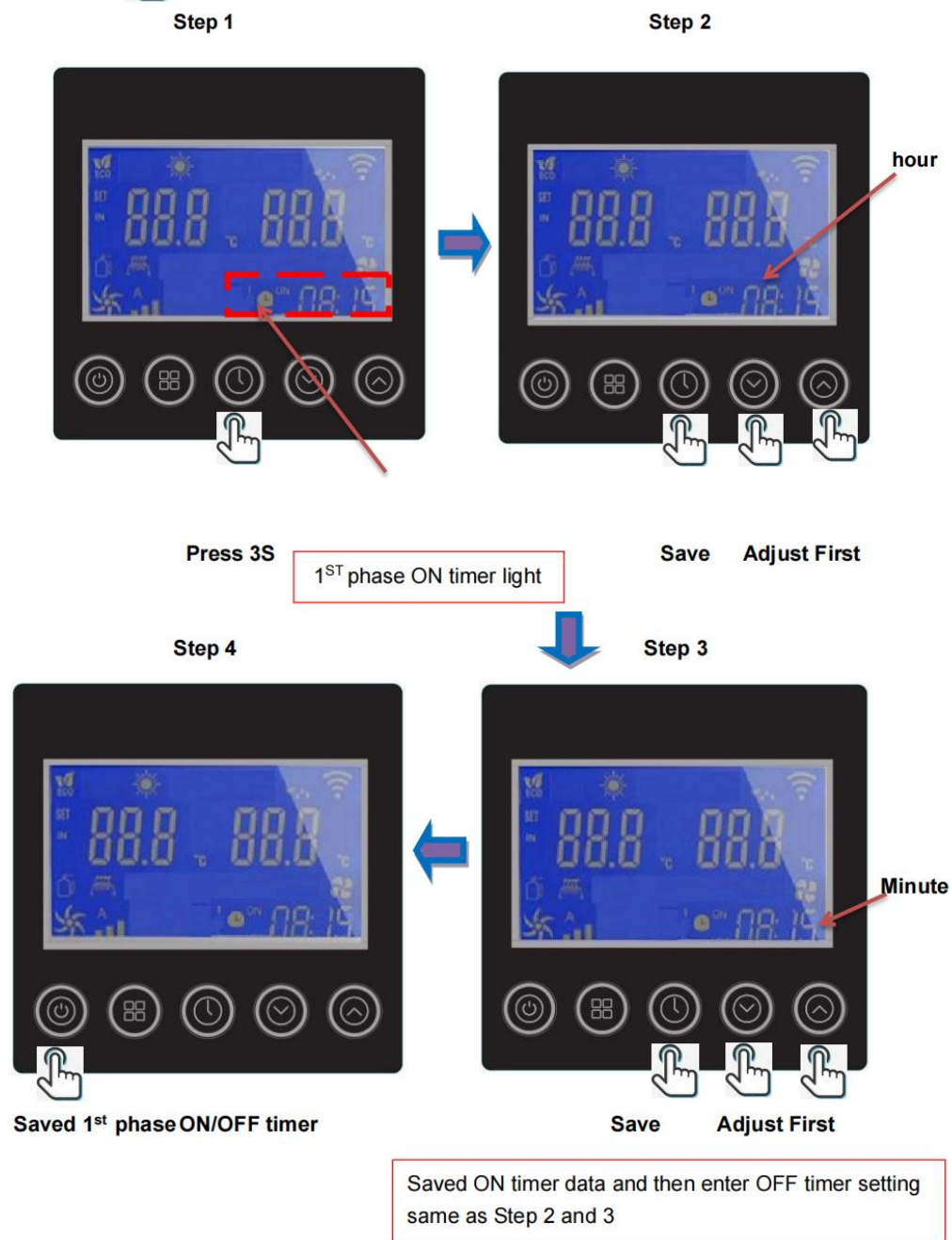

If you have set 08:15 ON in the timer , heat pump will start to work at 08:15 every day. Timer OFF will also repeat every day.

(Remark:  mean the first step)



7.8 The Phase 2、3 timer on/off setting:



The Phase 2 and 3 timer on/off setting:



Different operation: After finished 1st phase ON/OFF timer setting, press  key to enter 2nd phase timer setting menu. Then you could see . For the 2nd and 3rd phase ON/OFF timer setting method, please follow up 1st phase ON/OFF timer setting steps.

7.9 Cancel Timer Function

After ON/OFF timer setting ,press and hold  for 3S to cancel TIMER function if you need.

7.10 Function checking

Function 1: Press  or  to check the parameters of heat pump.

Function 2: In the main menu of heat pump ON, press  or  to set the temperature for current Mode selection. Press  to save and return to main menu after setting.

8. WiFi connection

8.1 Download the APP in your smart phone:



8.2 WiFi connection





Step 1: WiFi connection:

The WiFi icon will flash then enter into WiFi connection.

If WiFi is connected successfully, the WiFi icon will be lighted over 5S, otherwise, WiFi connection is failure, then please reconnect as below:

Method 1: Restart the controller

Method 2: Press and simultaneously hold 3 keys  +  +  for 5S to re-set the WiFi module.

8.3 User registration

When using the "smart life" software for the first time, user registration is required.

Click the " Create New User" link to enter the registration interface.

If you already have an account, just click to login.

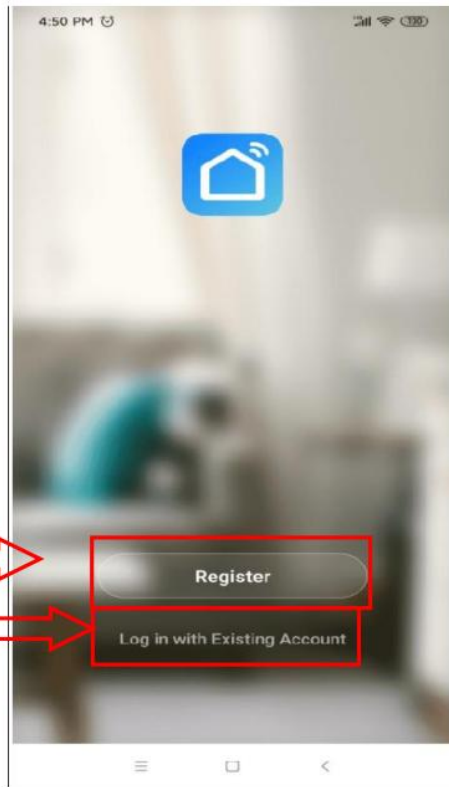

After entering the registration page, please follow the instruction on the page to register.

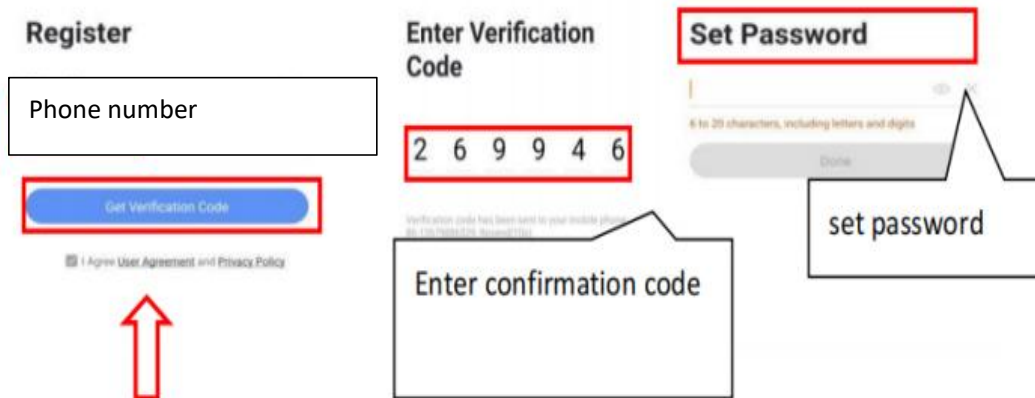

Enter the phone number to register and click to Next.

User login

After successful registration, the software will jump to the login interface or directly log in successfully,

enter the correct "user name" and "password" to log in.

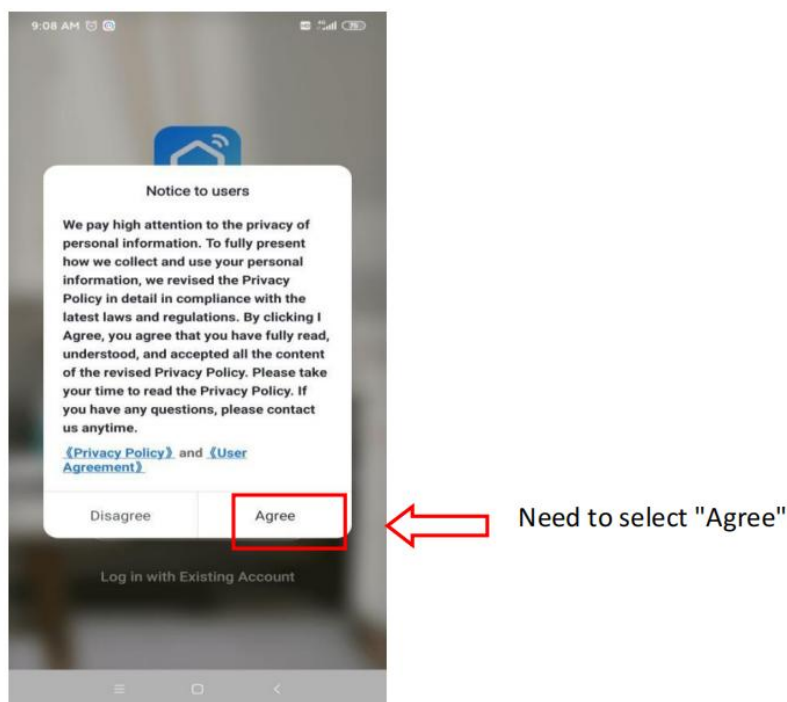

The phone needs to be connected to the network through the WIFI network

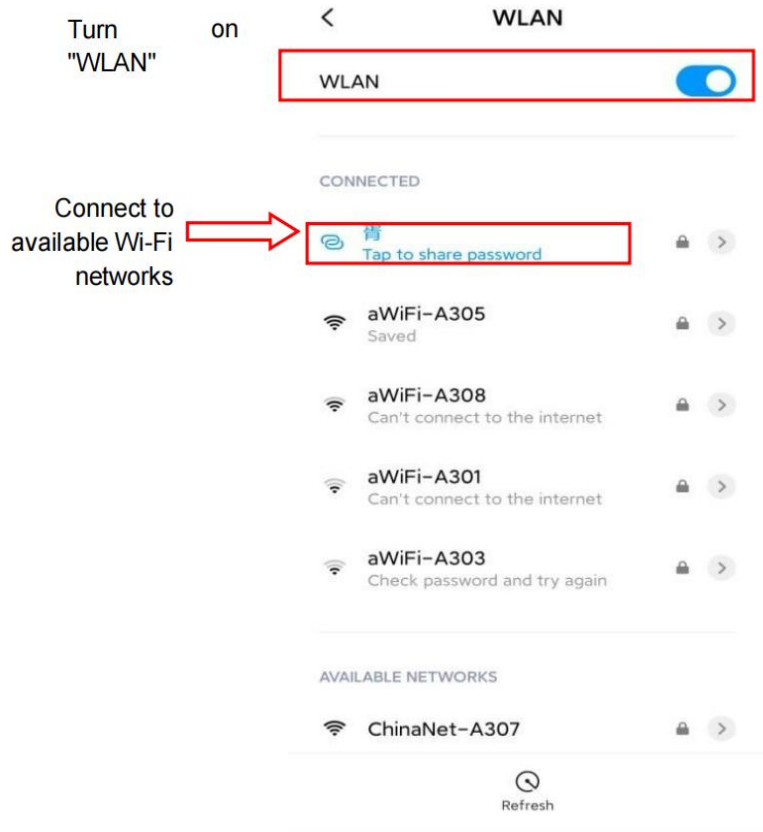

After users log in the APP, devices can be added.
Device connect
Click "+" or "Add Device" in the upper right corner to connect.

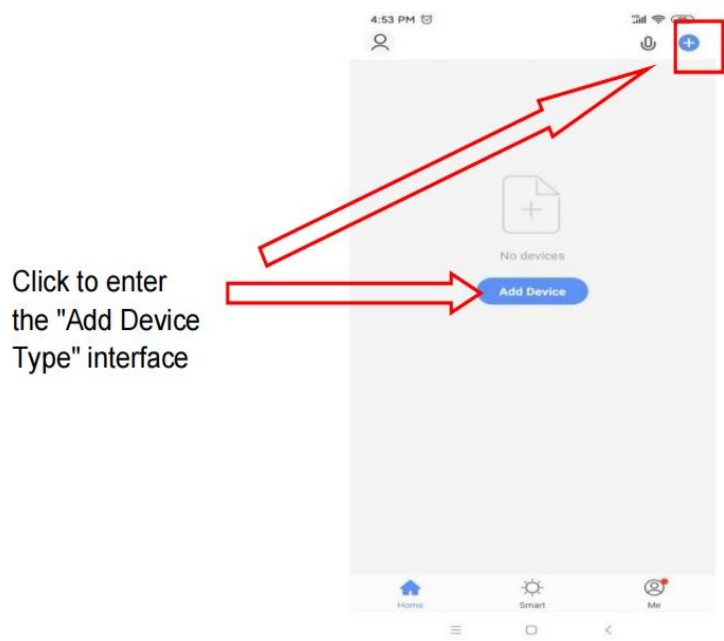

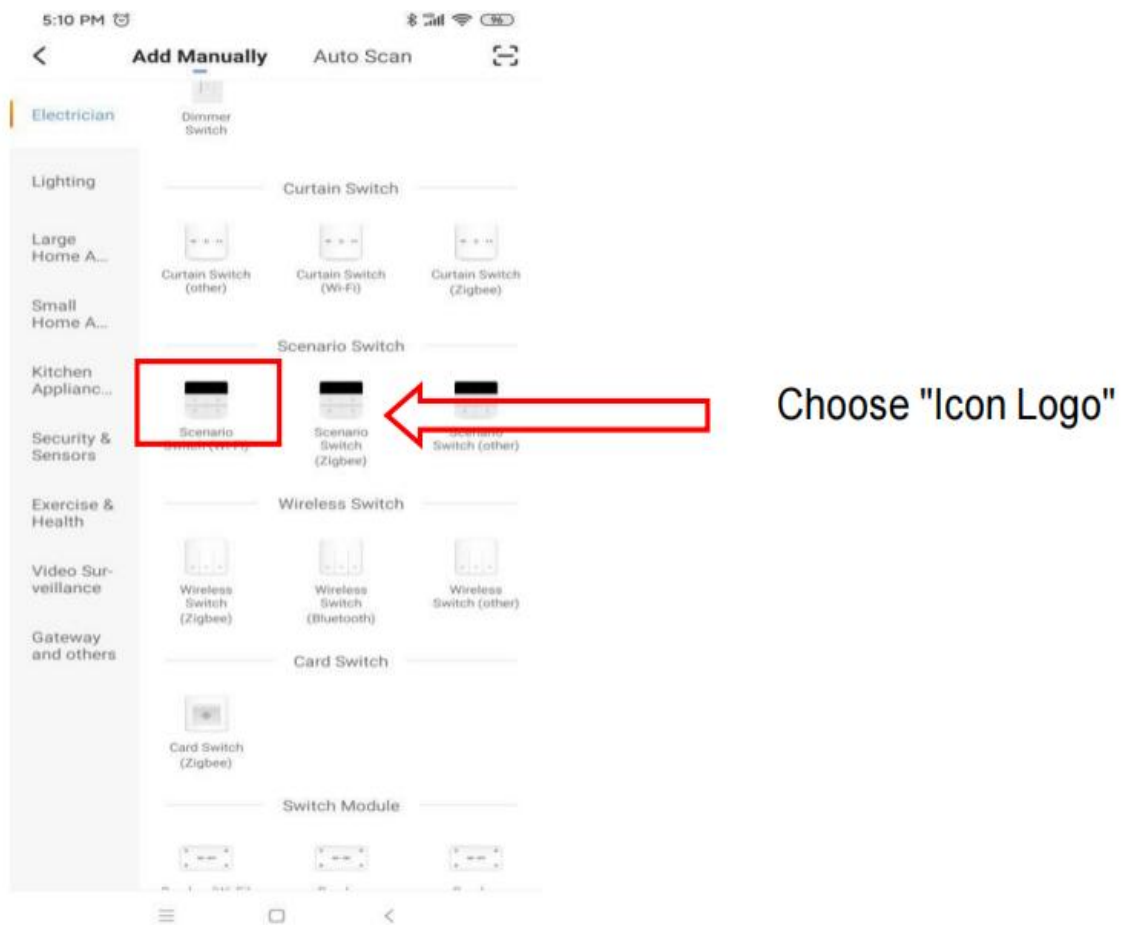

After completing the "Select Device Type", enter the "Add Device Interface", and the network configuration methods are divided into "default mode (WI-FI fast connection)" and "compatibility mode (hotspot distribution network)"

Default mode (WI-FI fast connection):

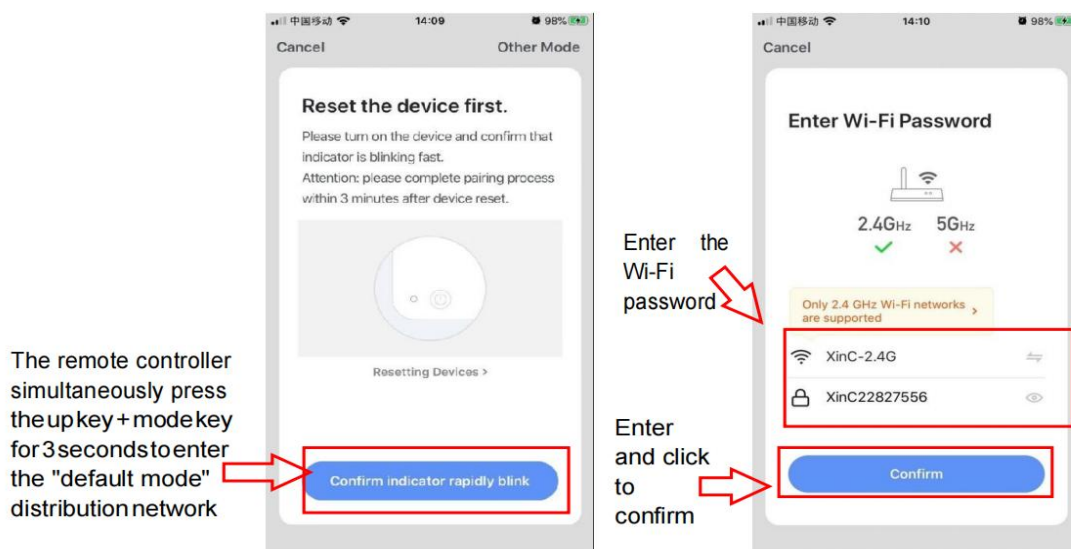

Enter the password and confirm it will jump to the connection interface

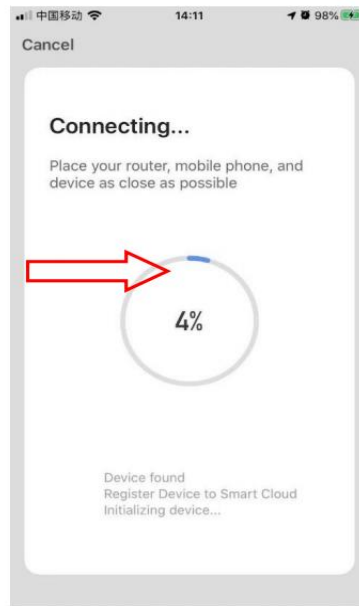

Device name can be modified

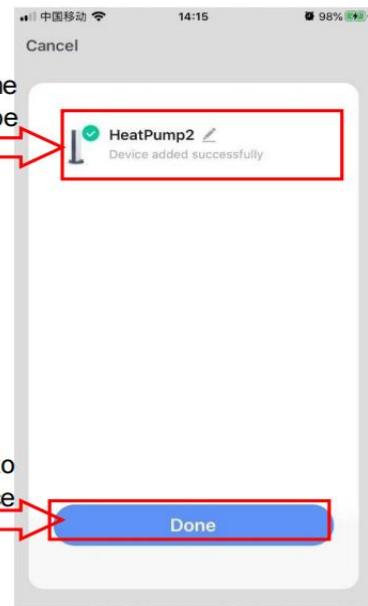

Click Finish to start device control

Device not responding Try "Switch Pairing Mode"

- ① Check if the device has been reset and the indicator is blinking quickly.
- ② Check if it is 2,4 GHz Wi-Fi.
- ③ Verify the Wi-Fi password.



[More device-pairing FAQs](#)



If the network distribution fails, the APP will display the page as shown in the figure, you can choose to re-add or view the help.

Compatibility mode:

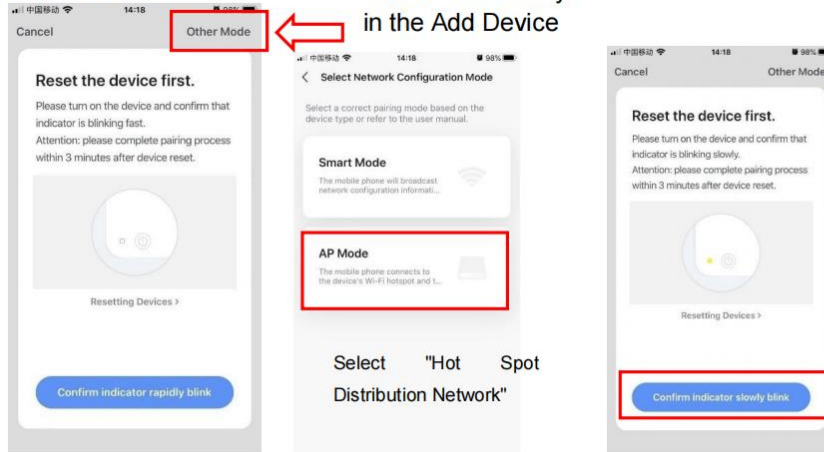

Press and hold the timing key +,down key +,power key simultaneously for 3 seconds to enter the "compatibility mode" distribution network.

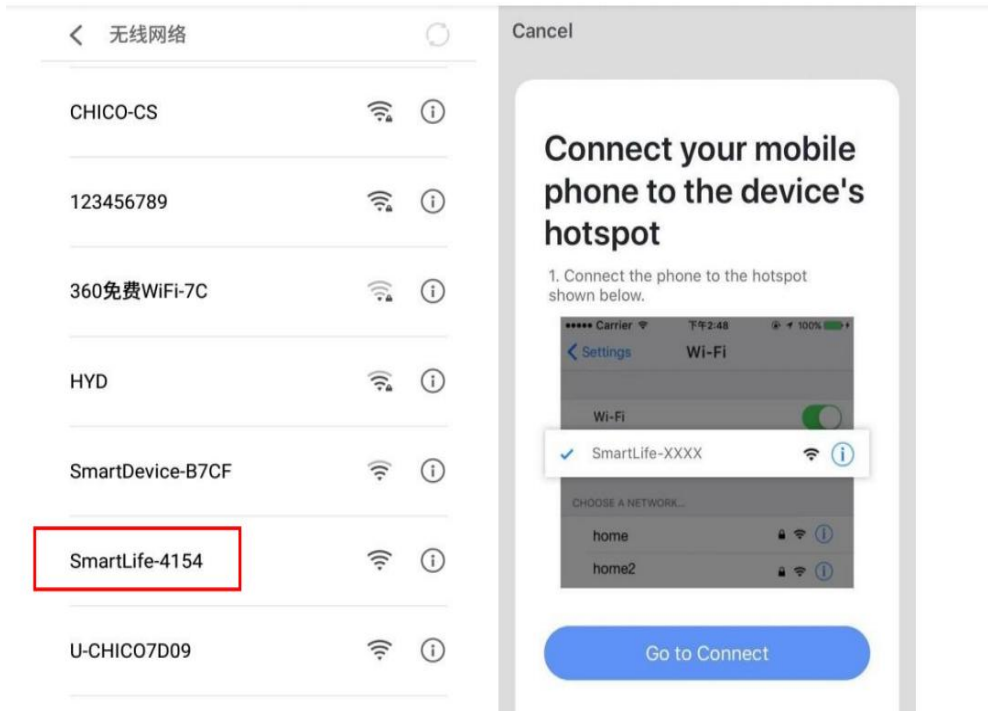

Click Go to connect and jump to the WiFi interface, select WiFi with the words. SmartLife- xxxx

After selecting and connecting, return to the APP interface and enter the network distribution process.

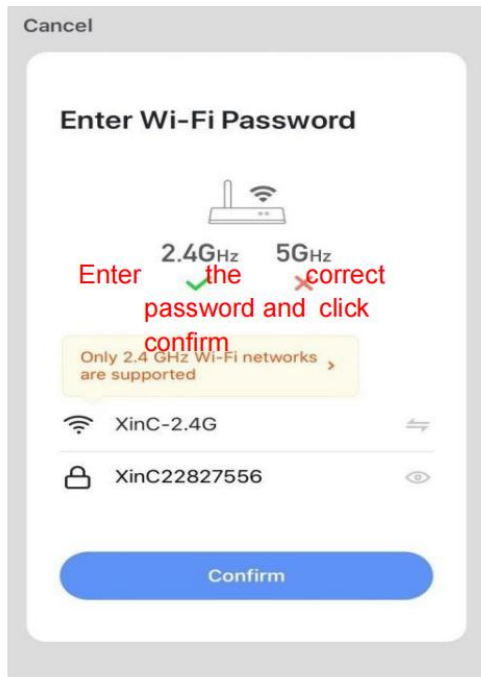

Control introduction

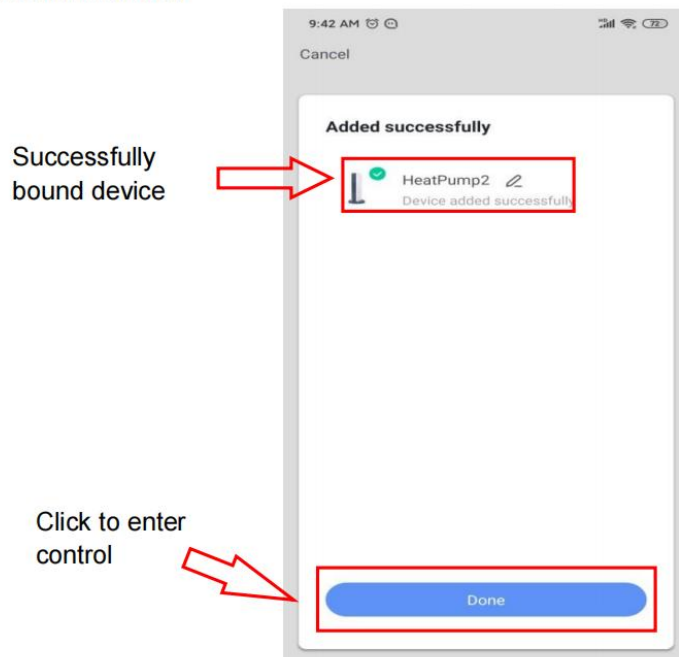

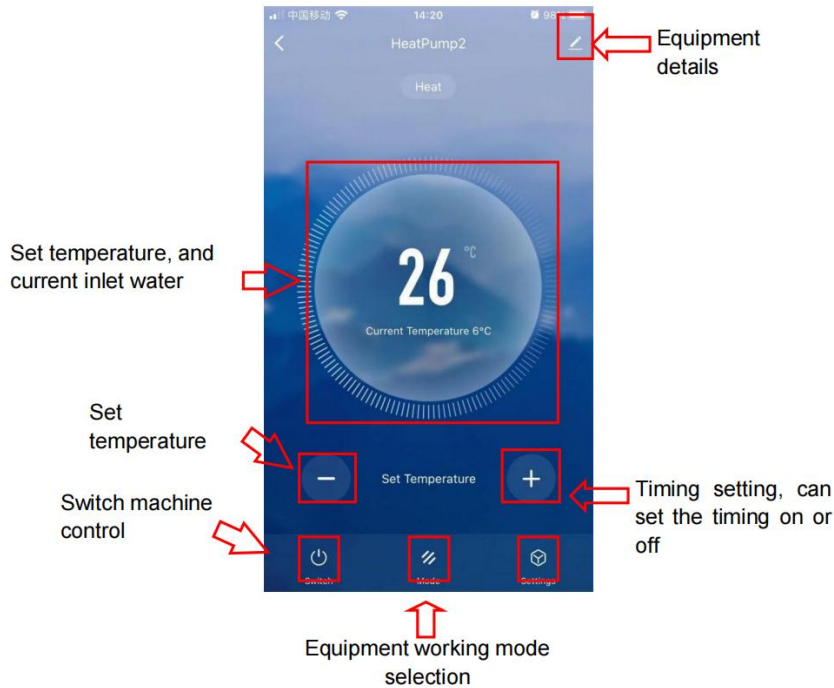









9.Parameter and Error codes











9.1 Parameter

Press  to enter Parameter status checking:

Code	Description	Code	Description
c01	Ambient temperature	c14	System failure
c02	Outside coil temperature	c15	driver failure
c03	Exhaust temperature	c16	signal output
c04	Suction pipe temperature	c17	running status
c05	Reserve	c18	AC voltage (V)
c06	Reserve	c19	DC voltage (V)
c07	Inside coil temperature (after throttle)	c20	Working frequency (Hz)
c08	Water inlet temperature	c21	EEV steps
c09	Water outlet temperature	c22	Reserve
c10	Reserve	c23	Heat pump current (A)
c11	Reserve	c24	Compressor current (A)
c12	Reserve	c25	DC Fan Speed (RPM)
c13	Sensor failure		

9.2 ICON LIST

NO	Icon	Description
1		Energy Conservation Mode
2		Powerful Working Mode
3		Heating Mode
4		Heating Mode
5		Water-Heating Mode only for BHP
6		Automatic Mode
7		Defrosting Mode
8		WIFI connection status

9	SET	Setting
10	IN	Water Inlet
11		Heat Pump Compressor
12		Electric Heater
13		Water Pump
14		4-Way valve
15		Heat Pump FAN
16	A 	Wind speed steps of FAN
17		Lock
18		Multi-phase Timer
19		Timer ON/OFF
20		Time

9.3 Error code

Code	Description	Troubleshooting and the fault cause
E03	Water flow switch failure or lack of water flux	<ol style="list-style-type: none"> 1. Whether the circulating water pump is normal and whether the water system is blocked. 2. Whether the water flow switch model is normal and whether the installation direction is correct. 3. Whether the water flow switch port wiring is correct. 4. Whether the pump lift meets the actual requirements. 5. Whether the water pump is reversed and the installation direction is wrong.
E04	Anti-freeze protection	Normal protection.
E05	High pressure protection	<ol style="list-style-type: none"> 1. Whether the pressure switch is damaged and the wiring is wrong. 2. Too much refrigerant in the system. 3. Whether the fan works normally and whether the water flow of the unit is normal. 4. The air inlet in the fluorine circuit system may be blocked. 5. Whether the water-side heat exchanger is seriously formed.
E06	Low pressure protection	<ol style="list-style-type: none"> 1. Whether the pressure switch is damaged and whether the wiring is correct. 2. Lack of refrigerant in the system. 3. Whether the fan works normally. 4. There is blockage in the fluorine circuit system.
E09	Communication failure between control main PC board and controller	Check the communication connection between the remote and the motherboard.
E10	Connection failure between driver board and main PC board	Check the communication connection between the driver board and the motherboard.
E11	After throttle temperature failure	<ol style="list-style-type: none"> 1. The sensor connection wire is disconnected or short-circuited. 2. The sensor is damaged. 3. The motherboard port is damaged.
E12	Exhaust temperature too high	<ol style="list-style-type: none"> 1. The fluorine system is blocked 2. Lack of refrigerant in the fluorine circuit system or bad sensor.
E15	Water inlet sensor failure	<ol style="list-style-type: none"> 1. The sensor connection wire is disconnected or short-circuited. 2. The sensor is damaged. 3. The motherboard port is damaged.
E16	Outside coil sensor failure	<ol style="list-style-type: none"> 1. The sensor connection wire is disconnected or short-circuited. 2. The sensor is damaged. 3. The motherboard port is damaged.
E18	Exhaust temperature sensor failure	<ol style="list-style-type: none"> 1. The sensor connection wire is disconnected or short-circuited. 2. The sensor is damaged. 3. The motherboard port is damaged.
E20	Drive module protection	The compressor or compressor drive board is bad.
E21	Ambient temperature failure	<ol style="list-style-type: none"> 1. The sensor connection wire is disconnected or short-circuited. 2. The sensor is damaged.

		3. The motherboard port is damaged.
E22	Vast temperature variations between inlet and outlet	1. The water inlet or outlet probe is damaged. 2. The inlet or outlet probe is not placed in the wrong position. 3. Insufficient water flow.
E23	Water outlet temperature lower in Cooling mode	1. Check whether the water flow is too low or no water flow. 2. Check whether the outlet probe is damaged. 3. The fluorine system is blocked.
E27	Water outlet sensor failure	1. The sensor connection wire is disconnected or short-circuited. 2. The sensor is damaged. 3. The motherboard port is damaged.
E29	Suction pipe sensor failure	1. The sensor connection wire is disconnected or short-circuited. 2. The sensor is damaged. 3. The motherboard port is damaged.
E30	Low outdoor ambient temperature protection	Normal protection.
E31	Auxiliary electric heating overload protection	1. Check if the auxiliary electric heating device is overloaded; 2. Check if the two plugs of the water pressure switch on the motherboard are short circuited.
E32	Water outlet temperature too high in Heat Mode	1. Check if the water flow rate of the entire water circuit is too low 2. Check if the sensor is damaged
E33	Outside coil temperature too high in Cooling Mode	1. Check if refrigeration is carried out when the ambient temperature is too high or the water temperature is too high; 2. Check if the sensor is damaged
E34	Compressor drive failure	1. If it happens accidentally, it belongs to normal protection action and can be automatically eliminated Resume operation; 2. Observe if the compressor can operate. If the compressor runs for a few minutes If a malfunction is reported later, it is necessary to check the compressor, electronic valve, fan, and water Whether the pump and other air conditioning system components are normal; 3. If the compressor malfunctions after only a few seconds of operation, it is necessary to check: Whether the appearance of the electronic control board is abnormal, whether the wiring terminals are reliable, and whether the compressor top is Whether the wiring is reliable; 4. If the above reasons are ruled out, the electronic control board needs to be replaced.
E35	Compressor current too high	1. The system matching is incorrect, and the operating load of the entire machine is too heavy. 2. Check whether the water flow is normal and whether the water pump is started.
E36	Compressor output failure	1. Check if the UVW wiring terminals on the electronic control board are secure; 2. Check if the UVW three-phase wiring terminals on the top of the compressor are secure;

		3. If the above wiring issues are ruled out, the electronic control board needs to be replaced.
E37	IPM current failure	Hardware failure of the electronic control board, replace the electronic control board
E39	Power overload shut down (PFC failure)	Incorrect system matching, excessive operating load on the entire machine
E40	DC Voltage too high	Due to high grid voltage, it belongs to normal protection and can be restored on its own
E41	DC Voltage too low	Due to low grid voltage, it belongs to normal protection and can be restored on its own
E42	Inside coil sensor failure	1. The sensor connection wire is disconnected or short-circuited. 2. The sensor is damaged. 3. The motherboard port is damaged.
E43	AC voltage too low	Due to voltage fluctuations in the power grid, it belongs to normal protection and can be restored on its own
E44	AC current too high	1. If it happens accidentally, it belongs to normal protection action and can be automatically eliminated and resumed operation 2. The voltage of the power grid in rural areas is unstable and often drops 3. Incorrect system matching, excessive operating load on the entire machine 4. If the above situation is ruled out and the malfunction still occurs, the electronic control board needs to be replaced.
E45	Driver E2 failure	Repaired by electronic control manufacturer, replacing E2prom chip
E46	DC fan failure	The fan drive board or motor is damaged.
E47	AC voltage too high	Due to voltage fluctuations in the power grid, it belongs to normal protection and can be restored on its own

10.Exploded View

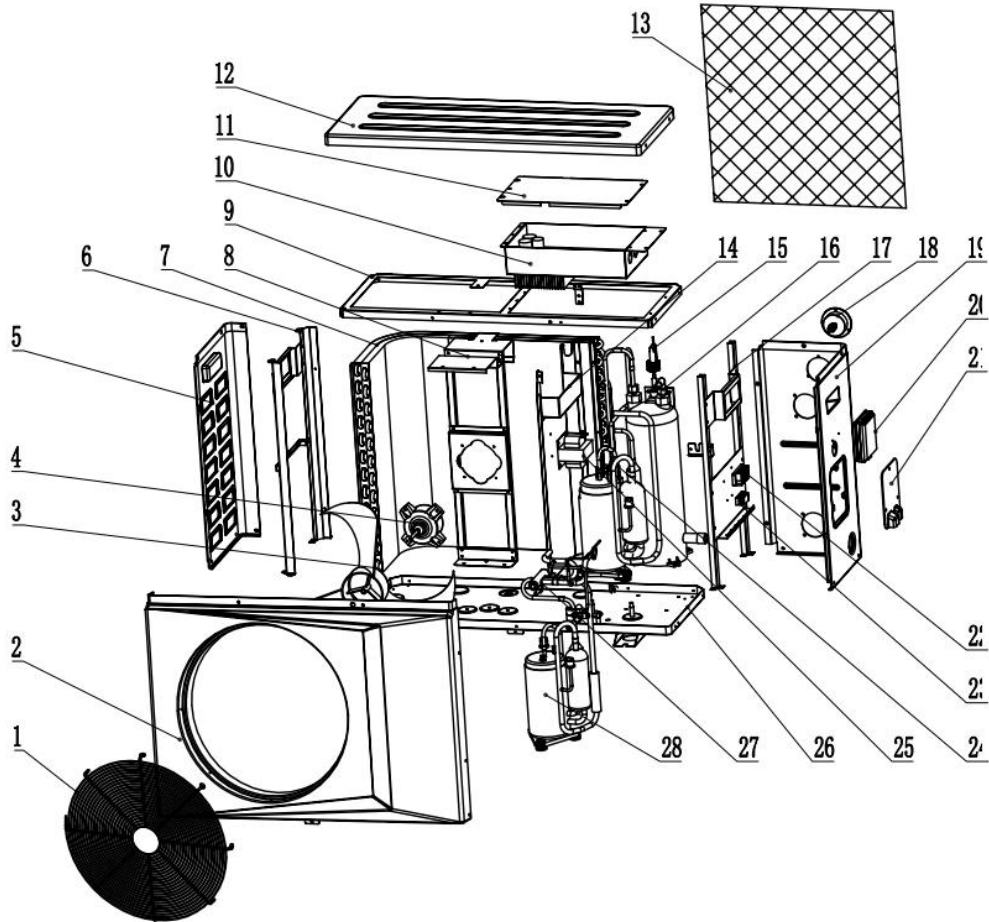

No.	Parts	No.	Parts
1	Ventilation grill	15	Water flow switch
2	Front panel	16	Titanium heat exchanger
3	Fan blade	17	Right structure
4	Fan motor	18	Manometer
5	Left panel	19	Right panel
6	Left structure	20	Control panel
7	Evaporator	21	Electrical terminal cover
8	Fan motor mount	22	Electrical terminal block
9	Upper structure	23	Electric cable support
10	Electric box cover	24	Electronic expansion valve
11	Electric box	25	Reactive resistance
12	Top cover	26	Bottom panel
13	Plastic net	27	4-way valve
14	Middle panel	28	Compressor

11.Operation logic

11.1 Operation logic

Silent Mode/Powerful Mode

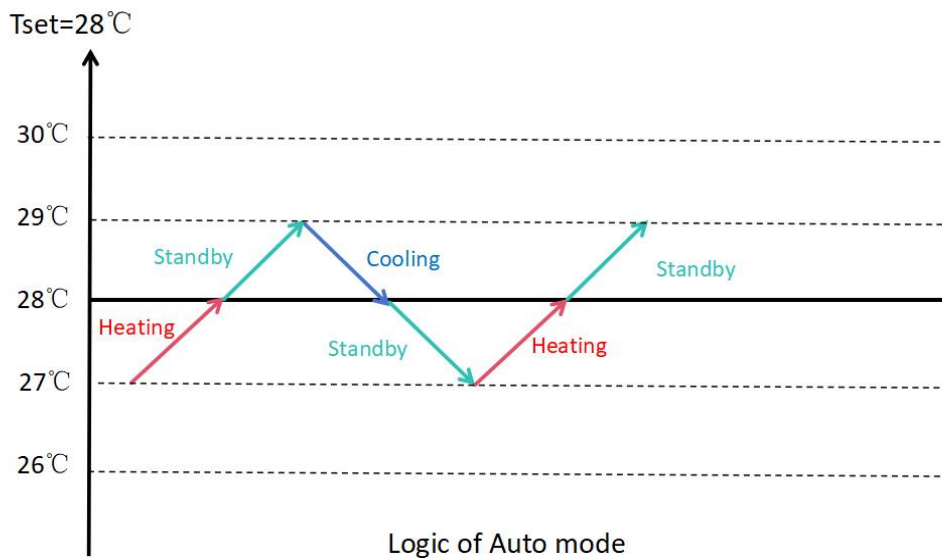
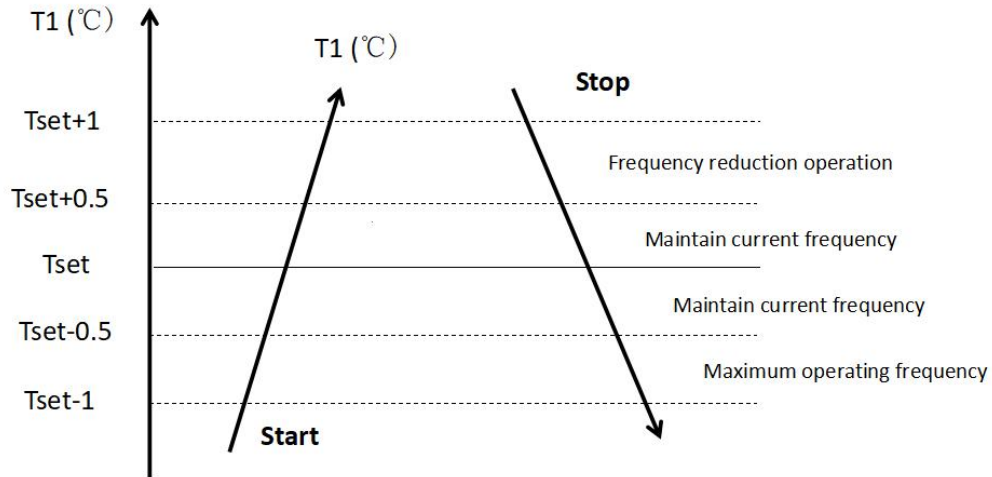

11.2 Defrosting logic

11.2.1 While heat pump system will enter into defrosting process, the cooling light



continues to flash.

11.2.2 Enter into defrosting process

No	Ambient temperature	Enter into defrosting process	
		Compressor working time since last defrosting process	Heating coil temperature
1	$\cong 20^{\circ}\text{C} > 4^{\circ}\text{C}$	40 minutes	-6°C
2	$\cong 4^{\circ}\text{C} > -3^{\circ}\text{C}$	40 minutes	-10°C
3	$\cong -3^{\circ}\text{C}$	100 minutes	Ambient temperature + (-6°C) eg: $-3^{\circ}\text{C} + (-6^{\circ}\text{C}) = -9^{\circ}\text{C}$

11.2.3 Exist defrosting process

No.	Exist defrosting process
1	Heating coil temperature $\geq 14^{\circ}\text{C}$
2	Heating coil temperature $\geq 8^{\circ}\text{C}$, and lasting in 90s
3	Defrosting period > 12 minutes

Important notice: When your heat pump meets any condition, it will exit defrosting process.

12. MAINTENANCE

- a. You should check the water supply system regularly to avoid air entering the system and creation of low water flow, because it would reduce the performance and reliability of HP unit.
- b. Clean your pools and filtration system regularly to avoid the damage of the unit.
- c. Only a qualified technician is authorized to operate the cooling system pressure. You should drain the water from the heat pump if it will stop running for a long time (especially during the winter season or when the ambient temperature drops below 0°C).
- d. Check the water levels before the unit start after a long break in usage.
- e. When the unit is running, there will be condensate water discharging from the bottom of the unit. This is normal.
- f. Action of filling gas must be conducted by professional with R32 operating license.

13. Winter Use

For Full Terms and Conditions please visit -
<http://www.cheshireluxurypools.co.uk/conditions.php>

13. Winter and Summer use of Heat Pumps

13a. For Winter usage the bottom drain tube and tubing supplied should be removed to prevent a build up of ice causing a blockage and thus the condensate will not be able to escape freely.

13b. If the Heat Pump Unit is to be used over the Winter Season, you MUST raise the unit to

an adequate and reasonable height from the ground, an absolute minimum of 10cms or 4 inches. This is to accommodate the condensate freely flowing away from the unit, preventing ice build up into the unit and causing any damage. This damage is not covered by the Warranty and will void ALL warranties.

Ice and snow build up should be taken into consideration too and must be kept from building up around the unit. This will choke the unit and stop the free exit of condensate amongst other bad effects, which may then affect the electricians of the unit and the fans etc. Necessary steps to protect the unit from this scenario should be taken.

It may be necessary to lift the unit on brackets and wall mount it for instance, so it is out of snow drift or high snow fall. Perhaps to build a shelter to protect the unit.

All warranties will be void if water ingress is found to be the cause of an electrical fault due to negligent usage and that the necessary steps have not been taken to protect the unit for Winter usage by the customer.

13c. For Summer usage the bottom drain tube and tubing supplied should be kept clean and free from debris if used.

13d. Failure to follow these instructions will void warranty for any parts broken or damaged.

